

**SIP**

**Mediant 1000**

# Installation Manual

Version 6.0





---

## Table of Contents

---

<b>1</b>	<b>Introduction.....</b>	<b>9</b>
<b>2</b>	<b>Installing the Device.....</b>	<b>11</b>
2.1	Physical Description.....	11
2.1.1	Front Panel.....	11
2.1.2	Rear Panel.....	14
2.2	Unpacking Package Contents.....	14
2.3	Mounting the Device.....	15
2.3.1	Desktop Mounting.....	15
2.3.2	Installing the Device in a 19-inch Rack.....	16
2.4	Cabling the Device.....	18
2.4.1	Connecting to Earth (Ground).....	19
2.4.2	Connecting to the IP Network.....	20
2.4.3	Connecting to FXS/FXO Interfaces.....	21
2.4.4	Connecting the Analog Lifeline Phone.....	21
2.4.5	Connecting to ISDN BRI Lines.....	23
2.4.6	Connecting to E1/T1 Trunks.....	24
2.4.7	Connecting to E1/T1 Trunks for PSTN Fallback.....	25
2.4.8	Connecting to Dry Contact Relay Alarm System.....	26
2.4.9	Connecting RS-232 Serial Interface to PC.....	27
2.4.10	Connecting to Power.....	28
2.5	Maintenance.....	29
2.5.1	I/O Module Slot Assignment.....	29
2.5.2	Replacing Modules.....	30
2.5.3	Inserting Modules into Previously Empty Slots.....	32
2.5.4	Replacing the Air Filter.....	33
<b>3</b>	<b>Configuring the Device.....</b>	<b>35</b>
3.1	Assigning an IP Address.....	35
3.1.1	Assigning an IP Address using HTTP.....	36
3.1.2	Assigning an IP Address using BootP.....	37
3.1.3	Assigning an IP Address using the Voice Menu Guidance.....	38
3.1.4	Assigning an IP Address Using the CLI.....	41
3.2	Configuring Basic SIP Parameters.....	42
3.2.1	Enabling Channels and Configuring Call Routing (Example).....	43
3.3	Configuring PSTN Trunks.....	45
3.4	Saving and Resetting the Device.....	47
3.5	Changing Login User Name and Password.....	48
3.6	Backing Up and Restoring Configuration.....	49
3.7	Restoring Factory Default Settings.....	50
3.8	Upgrading the Device.....	51
3.8.1	Software Upgrade Wizard.....	51
3.8.2	Loading ini and Auxiliary Files.....	55
<b>4</b>	<b>Monitoring the Device.....</b>	<b>57</b>
4.1	Front-Panel LEDs.....	57
4.2	Web Interface.....	59
4.2.1	Viewing Alarms.....	59

---

4.2.2	Viewing Channel Status .....	60
<b>5</b>	<b>Open Solution Network (OSN) Server Platform .....</b>	<b>61</b>
5.1	OSN1/OSN2 Hardware Installation .....	61
5.1.1	Required Working Tools .....	63
5.1.2	Installing the CM Module .....	63
5.1.3	Installing the iPMX Module .....	64
5.1.4	Installing the HDMX Module .....	65
5.1.5	Replacing the iPMX Module's Lithium Battery .....	66
5.2	Installing Linux™ on the OSN Server.....	68
5.2.1	Requirements.....	68
5.2.2	Cabling.....	69
5.2.2.1	Cabling OSN1.....	69
5.2.2.2	Cabling OSN2.....	70
5.2.3	Installing Linux .....	71
5.3	Connecting Remotely to OSN Server using Windows.....	73
5.3.1	Cabling.....	73
5.3.2	Connecting Using Remote Desktop Connection .....	74

---

## List of Figures

---

Figure 1-1: Summary of Steps for Installing the Device .....	9
Figure 2-1: Front-Panel View and CPU Enlargement.....	11
Figure 2-2: Rear Panel .....	14
Figure 2-3: Attached Rubber Foot on Underside of Chassis.....	15
Figure 2-4: Location of Grooves for Rubber Feet.....	15
Figure 2-5: Peeled-off Rubber Foot.....	16
Figure 2-6: Earthing the Device .....	19
Figure 2-7: RJ-45 Connector Pinouts .....	20
Figure 2-8: RJ-11 Connector Pinouts .....	21
Figure 2-9: RJ-11 Connector Pinouts for FXS Lifeline .....	22
Figure 2-10: Mediant 1000 Analog Lifeline Cable Setup .....	22
Figure 2-11: RJ-45 Connector Pinouts for BRI Ports .....	23
Figure 2-12: RJ-48c Connector Pinouts for E1/T1 .....	24
Figure 2-13: Mediant 1000 Digital Lifeline Cabling (e.g., Trunks 1 and 2) .....	25
Figure 2-14: Dry Contact Wires' Mate .....	26
Figure 2-15: RS-232 Cable Adaptor .....	27
Figure 2-16: Power Supply Module .....	28
Figure 2-17: Mediant 1000 Front Layout .....	29
Figure 2-18: Recommended Priority Module Slot Assignment.....	30
Figure 2-19: Module Orientation in Chassis Top- and Bottom-Row Slots.....	31
Figure 2-20: Slightly Extracted Fan Tray Unit.....	33
Figure 2-21: Fan Tray with Filter Removed .....	34
Figure 3-1: Enter Network Password Screen .....	36
Figure 3-2: BootP Client Configuration Screen .....	38
Figure 3-3: Enabling Channels in Trunk Group Table Page.....	43
Figure 3-4: Routing Tel Calls to an IP Address .....	44
Figure 3-5: Trunk Settings Page.....	45
Figure 3-6: Maintenance Actions Page.....	47
Figure 3-7: WEB User Accounts Page (for Users with 'Security Administrator' Privileges) .....	48
Figure 3-8: Configuration File Page.....	49
Figure 3-9: Start Software Upgrade Wizard Screen .....	52
Figure 3-10: Load CMP File Wizard Page.....	53
Figure 3-11: End Process Wizard Page .....	54
Figure 3-12: Load Auxiliary Files Page.....	56
Figure 4-1: Location of Front-Panel LEDs .....	57
Figure 4-2: Current Alarms in Active Alarms Page.....	59
Figure 4-3: Mediant 1000 Web Interface's Home Page .....	60
Figure 5-1: Connection Module - CM (Only for Celeron-Based OSN Server).....	61
Figure 5-2: iPMX Module (Only for OSN1) .....	62
Figure 5-3: iPMX Module (For OSN2) .....	62
Figure 5-4: Hard Drive Module (HDMX) .....	62
Figure 5-5: Inserting CM Module .....	63
Figure 5-6: Cover Plates Removed .....	64
Figure 5-7: Cutting Metal Strip.....	64
Figure 5-8: Inserting iPMX Module .....	65
Figure 5-9: Inserting HDMX Module .....	66
Figure 5-10: Removing Lithium Battery from iPMX Module .....	67
Figure 5-11: Cabling OSN1 (CM Module) .....	69
Figure 5-12: Cabling OSN2 (iPMX Module in Rear Panel).....	70
Figure 5-13: System BIOS Setup Window .....	71
Figure 5-14: Enabling System Management BIOS.....	72
Figure 5-15: Saving BIOS Settings.....	72
Figure 5-16: Cabling iPMX for Remote Connection from PC with Windows XP .....	73
Figure 5-17: Changing the PC's IP Address.....	74
Figure 5-18: Entering IP Address in Remote Desktop Connection .....	75
Figure 5-19: Entering User Name and Password in Remote Desktop Connection.....	75

---

## List of Table

---

Table 2-1: Front Panel Component Descriptions .....	12
Table 2-2: Rear Panel Component Descriptions .....	14
Table 2-3: FXS Lifeline Setup Component Descriptions .....	22
Table 2-4: Dry Contact Operational Description .....	26
Table 3-1: Default IP Addresses .....	35
Table 3-2: Configuration Parameters Available via the Voice Menu .....	40
Table 3-3: Auxiliary Files Descriptions .....	55
Table 4-1: Analog I/O (FXS / FXO) Modules LEDs Description .....	57
Table 4-2: E1/T1 PRI I/O TRUNKS Modules LED Description .....	57
Table 4-3: BRI I/O Modules LED Description .....	58
Table 4-4: Power Supply Module LED Description .....	58
Table 4-5: CPU Module LEDs Description .....	58
Table 4-6: Color-Coding of Trunk / Channel Status Icon .....	60

## Notice

This Installation Manual describes the hardware installation and quick configuration setup for AudioCodes Mediant 1000 Voice-over-IP (VoIP) SIP (analog and digital) media gateway.

Information contained in this document is believed to be accurate and reliable at the time of printing. However, due to ongoing product improvements and revisions, AudioCodes cannot guarantee accuracy of printed material after the Date Published nor can it accept responsibility for errors or omissions. Before consulting this document, check the corresponding Release Notes regarding feature preconditions and/or specific support in this release. In cases where there are discrepancies between this document and the Release Notes, the information in the Release Notes supersedes that in this document. Updates to this document and other documents can be viewed by registered customers at <http://www.audiocodes.com/downloads>.

© Copyright 2010 AudioCodes Ltd. All rights reserved.

This document is subject to change without notice.

Date Published: February-23-2010

## Trademarks

AudioCodes, AC, AudioCoded, Ardito, CTI2, CTI<sup>2</sup>, CTI Squared, HD VoIP, HD VoIP Sounds Better, InTouch, IPmedia, Mediant, MediaPack, NetCoder, Netrake, Nuera, Open Solutions Network, OSN, Stretto, TrunkPack, VMAS, VoicePacketizer, VoIPerfect, VoIPerfectHD, What's Inside Matters, Your Gateway To VoIP and 3GX are trademarks or registered trademarks of AudioCodes Limited. All other products or trademarks are property of their respective owners.

## WEEE EU Directive

Pursuant to the WEEE EU Directive, electronic and electrical waste must not be disposed of with unsorted waste. Please contact your local recycling authority for disposal of this product.

## Customer Support

Customer technical support and service are provided by AudioCodes' Distributors, Partners, and Resellers from whom the product was purchased. For Customer support for products purchased directly from AudioCodes, contact [support@audiocodes.com](mailto:support@audiocodes.com).

## Abbreviations and Terminology

Each abbreviation, unless widely used, is spelled out in full when first used. Only industry-standard terms are used throughout this manual. Hexadecimal notation is indicated by 0x preceding the number.

## Related Documentation

Document Name
Product Reference Manual
Mediant 600 and Mediant 1000 SIP Release Notes
Mediant 600 and Mediant 1000 SIP User's Manual
CPE Configuration Guide for IP Voice Mail



**Notes:** Throughout this manual and unless otherwise specified, the term *device* refers to the Mediant 1000 gateway.



**Note:** The device is an **indoor** unit and therefore, must be installed only indoors.



### Caution Electrical Shock

Do not open or disassemble this device. The device carries high voltage and contact with internal components may expose you to electrical shock and bodily harm.



**Warning:** Disconnect the gateway from the mains and Telephone Network Voltage (TNV) before servicing.



**Warning:** To protect against electrical shock and fire, use a 26-AWG min wire to connect FXO ports to the Public Switching Telephone Network (PSTN).



**Notes:**

- FXO (Foreign Exchange Office) is the interface replacing the analog telephone and connects to a Public Switched Telephone Network (PSTN) line from the Central Office (CO) or to a Private Branch Exchange (PBX). The FXO is designed to receive line voltage and ringing current, supplied from the CO or the PBX (just like an analog telephone). An FXO VoIP device interfaces between the CO/PBX line and the Internet.
- FXS (Foreign Exchange Station) is the interface replacing the Exchange (i.e., the CO or the PBX) and connects to analog telephones, dial-up modems, and fax machines. The FXS is designed to supply line voltage and ringing current to these telephone devices. An FXS VoIP device interfaces between the analog telephone devices and the Internet.



**Warning:** FXO ports are considered to be TNV-3; FXS ports are considered to be TNV-2.

# 1 Introduction

This manual provides you with step-by-step procedures for initial and basic setup of the device, including hardware installation and software configuration. The flowchart below summarizes these steps.

**Figure 1-1: Summary of Steps for Installing the Device**

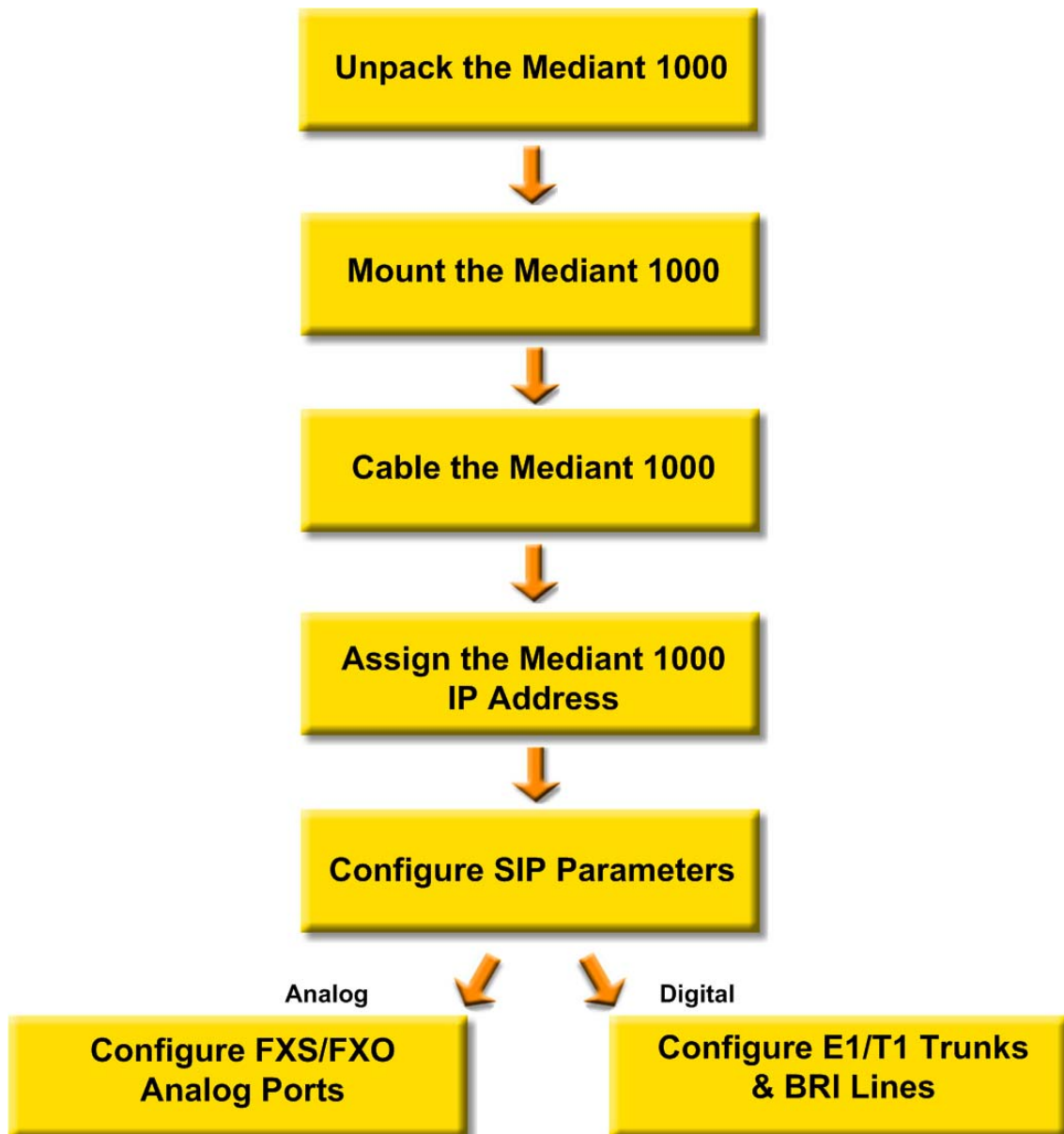

**Notes:**

- For detailed information on how to fully configure the device, refer to the device's *User's Manual*.
- Prior knowledge of IP networking is recommended.

**Reader's Notes**

## 2 Installing the Device

This section describes the device's hardware installation, which includes the following:

- Physical description of the device (refer to 'Installing the Device' on page 11)
- List of shipped items (refer to 'Unpacking Package Contents' on page 14)
- Mounting the device (refer to 'Mounting the Device' on page 15)
- Cabling the device (refer to 'Cabling the Device' on page 17)

### 2.1 Physical Description

This section provides a physical description of the device's front (refer to 'Front Panel' on page 11) and rear panels (refer to 'Rear Panel' on page 13).

The device is designed with a 19-inch industrial platform chassis, 1U high and 13.8 inch deep. The device supports a scalable, modular architecture providing replaceable modules.

#### 2.1.1 Front Panel

The device's front panel is shown in the figure below and described in the subsequent table.

**Figure 2-1: Front-Panel View and CPU Enlargement**

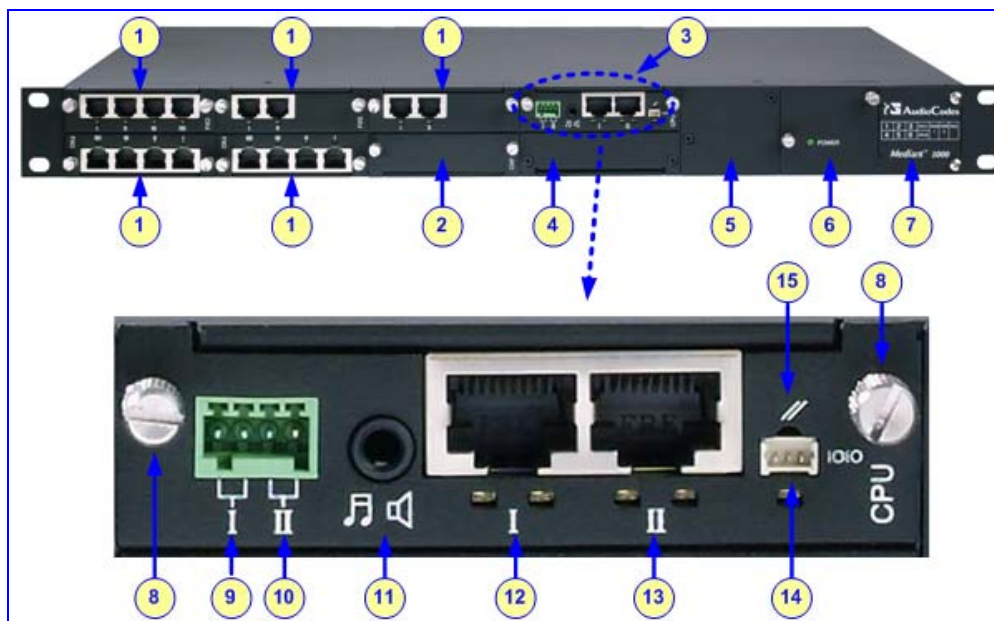

**Note:** The above figure is used only as an example. The number and type of interface modules depends on the ordered configuration.

**Table 2-1: Front Panel Component Descriptions**

Item #	Label/ Module	Component Description
1	<b>FXO</b>	(Optional) FXO and FXO G module: The device can house up to six FXO modules. Each module provides four RJ-11 ports. Therefore, up to 24 FXO ports (i.e., 6 modules x 4 ports) are supported.  <b>Note:</b> The standard FXO module supports outdoor and indoor (lightning protection) loop-start signaling. The <b>FXO G</b> module supports both loop- and ground-start signaling (but only supports indoor protection). To enable ground-start signaling, use the <i>ini</i> file parameter GroundKeyDetection (refer to the device's <i>User's Manual</i> ).
	<b>FXS</b>	(Optional) FXS module: The device can house up to six FXS modules. Each module provides four RJ-11 ports. Therefore, up to 24 FXS ports (i.e., 6 modules x 4 ports) are supported.  <b>Note:</b> The FXS modules support both loop- and ground-start signaling.
	<b>TRUNKS</b>	(Optional) TRUNKS module: The device supports up to four digital E1/T1/J1 trunks. The modules are available in 1- or 2- or 4-span configurations (RJ-48c ports). If the power fails, a relay connects trunks 1 to 2, and 3 to 4 (in the same module) acting as a fallback for PSTN trunk.
	<b>BRI</b>	(Optional) BRI module: The device supports up to five BRI modules. Each module provides up to four BRI line (RJ-45) ports, therefore, up to 20 BRI ports are supported.
2	<b>MPM</b>	(Optional) Media Processing Module (MPM): The device supports up to three MPM modules for IP media server capabilities (i.e., conferencing, and IP-to-IP routing applications). These modules can be housed in slots 3, 4, 5, or 6, depending on required configuration (for a detailed description of channel resources using MPM modules, refer to the device's <i>User's Manual</i> ).
3	<b>CPU</b>	Main CPU module.
4	<b>CPU</b>	This slot can either house a spare Central Processing Unit (CPU) module or the Connection module (OSN server). For OSN Server installation, refer to the device's <i>User's Manual</i> .
5	<b>Power 1</b>	(Optional) Spare Power Supply module slot. The device can provide two extractable power supply units (Power 1 and Power 2). Each power supply unit provides an AC power connector on its rear panel. If both Power 1 and Power 2 units are used, the load is shared between them. This (optional) load-sharing feature enables power failure protection (redundancy). When using this feature, you are advised to connect each power supply unit to a different AC supply circuit.
6	<b>Power 2</b>	Main Power Supply module (refer to the above description).
7	<b>Schematic</b>	Extractable Fan Tray module with a schematic displayed on its front panel showing the chassis' slot numbers. The Fan Tray module cools the device's components. For additional information, refer to 'Replacing the Air Filter' on page <a href="#">32</a> .

Item #	Label/ Module	Component Description
<b>CPU - Enlarged View (#3)</b>		
8	-	Locking screws (2).
9	I	Dry contact port (normally open) - can be connected to an external audible or visual alarm system (e.g., bell, siren, hooter, or light).
10	II	Dry contact port (normally closed).
11		Audio IN/OUT. (Currently, not applicable.)
12	I	10/100Base-TX Ethernet Port 1. Two Ethernet ports provide a dual Ethernet redundancy scheme, protecting against failure such as a disconnection of any cable or associated LAN switch port. These ports support auto-negotiation, half- and full-duplex modes, and straight-through and crossover cable detection.
13	II	10/100Base-TX Ethernet Port 2.
14	IOIO	RS-232 port for accessing the CLI and for receiving error / notification messages. A 9-pin DB adaptor cable is supplied.
15	//	Reset button for resetting the device and optionally, for restoring the device's parameters to their factory defaults (refer to 'Restoring Factory Default Settings' on page 50).



**Note:** For module slot assignment, refer to 'I/O Module Slot Assignment' on page 29.

## 2.1.2 Rear Panel

The device's rear panel provides the power connectors, which are located on the power supply module, as shown in the figure below and described in the subsequent table.

**Figure 2-2: Rear Panel**

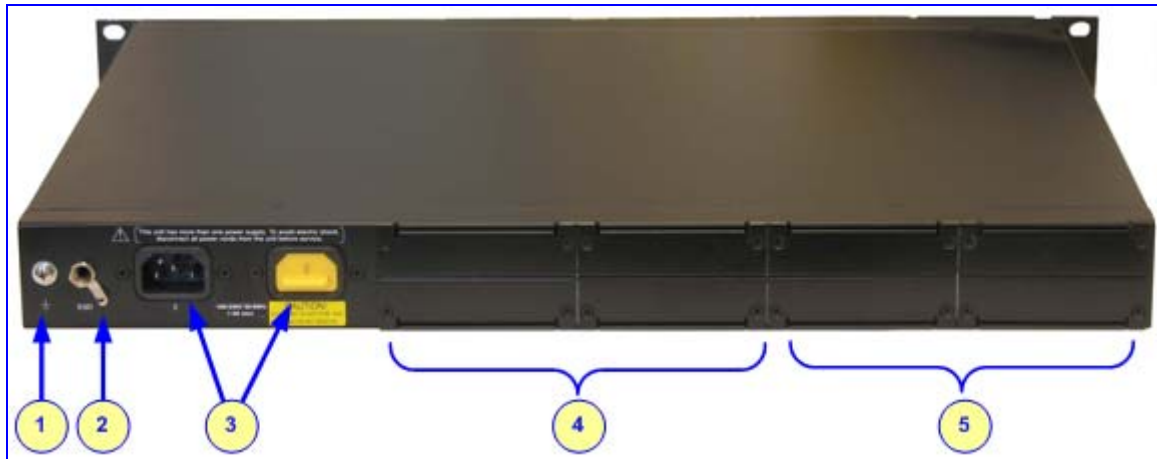

**Table 2-2: Rear Panel Component Descriptions**

Item #	Label	Component Description
1		Protective earthing screw.
2	ESD	Electrostatic Discharge (ESD) socket.
3	100-240V~1A	Dual AC Power Supply Entry.
4	-	Slots for housing optional OSN server modules (refer to Open Solution Network (OSN) Server Platform on page 61).
5	-	Slots reserved for future use.

## 2.2 Unpacking Package Contents

Follow the procedure below for unpacking the carton in which the device is shipped.

➤ **To unpack the device:**

1. Open the carton and remove packing materials.
2. Remove the chassis from the carton.
3. Check that there is no equipment damage.
4. Ensure that in addition to the chassis, the package contains the following items:
  - One or two AC power cables.
  - Four anti-slide bumpers for desktop installation option.
  - Two-meter length RS-232 DB-9 adaptor cable (for direct serial connection to PC).
5. Check, retain and process any documents.
6. Notify AudioCodes or your local supplier of any damage or discrepancies.

## 2.3 Mounting the Device

The device can be mounted in one of the following ways:

- Placed on a desk top (refer to 'Desktop Mounting' on page 15)
- Installed in a standard 19-inch rack (refer to 'Installing the Device in a 19-inch Rack' on page 16)

### 2.3.1 Desktop Mounting

The device can be mounted on a desktop by attaching the four anti-slide bumpers (supplied) to the underside of the device. Once you have attached these bumpers, simply place it on a desktop in the desired position.

**Figure 2-3: Attached Rubber Foot on Underside of Chassis**



➤ **To attach the anti-slide rubber bumpers to the device:**

1. Flip the device over so that its underside faces up.
2. Locate the four anti-slide grooves on the underside - one on each of the four corners.

**Figure 2-4: Location of Grooves for Rubber Feet**

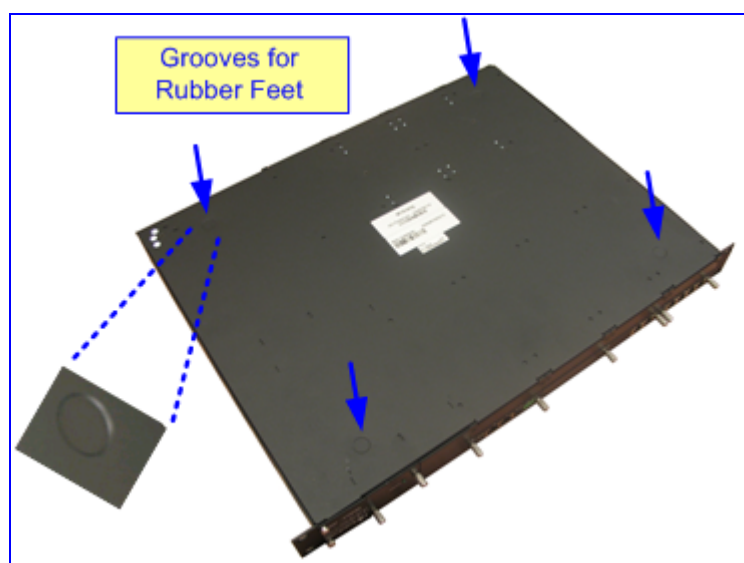

3. Peel off the adhesive, anti-slide rubber feet and stick one in each anti-slide groove.

**Figure 2-5: Peeled-off Rubber Foot**

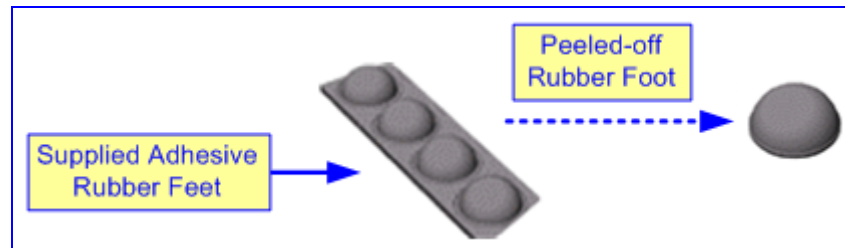

4. Flip the device over again so that it rests on its underside and place it in the required position on a desktop.

## 2.3.2 Installing the Device in a 19-inch Rack

The device can be installed in a standard 19-inch rack by implementing one of the following methods:

- Placing it on a pre-installed shelf in a 19-inch rack (recommended method).
- Attaching it directly to the rack's frame using the device's integral front mounting brackets and the user-adapted rear mounting brackets (not supplied). This method is required for racks that don't provide shelves.



### Rack Mount Safety Instructions

When installing the chassis in a rack, implement the following safety instructions:

- **Elevated Operating Ambient Temperature:** If installed in a closed or multi-unit rack assembly, the operating ambient temperature of the rack environment may be greater than room ambient temperature. Therefore, consideration should be given to installing the equipment in an environment compatible with the maximum ambient temperature (T<sub>ma</sub>) of 45°C (113°F).
- **Reduced Air Flow:** Installation of the equipment in a rack should be such that the amount of air flow required for safe operation on the equipment is not compromised.
- **Mechanical Loading:** Mounting of the equipment in the rack should be such that a hazardous condition is not achieved due to uneven mechanical loading.
- **Circuit Overloading:** Consideration should be given to the connection of the equipment to the supply circuit and the effect that overloading of the circuits might have on overcurrent protection and supply wiring. Appropriate consideration of equipment nameplate ratings should be used when addressing this concern.
- **Reliable Earthing:** Reliable earthing of rack-mounted equipment should be maintained. Particular attention should be given to supply connections other than direct connections to the branch circuit (e.g., use of power strips.)

➤ **To mount the device on a pre-installed shelf in the rack:**

- Place the device on a pre-installed shelf in the rack. It's recommended to attach the device's integral front mounting brackets to the rack's frame to prevent it from sliding off the shelf during cabling. Use standard 19-inch rack bolts (not provided) to fasten the front of the device to the frame of the rack.

➤ **To install the device in a rack without shelves:**

1. Position the device in a 19-inch rack and align the *front and rear* (refer to note below) bracket holes to the holes (of your choosing) in the vertical tracks of the 19-inch rack.
2. Use standard 19-inch rack bolts (not provided) to fasten the brackets to the frame of the rack.



**Note:** If you are assembling the rear brackets, please note the following:

- The distance between the screws on each bracket is 28 mm (1.1 inches).
- To attach the brackets, use 4-40 screws with a maximal box penetration length of 3.5 mm (0.14 inch).

## 2.4 Cabling the Device

This section describes the cabling of the device, which includes the following:

- Connecting to earth/ground (refer to 'Earthing (Grounding) the Device' on page 18)



### Protective Earthing

The equipment is classified as Class I EN60950 and UL60950 and must be earthed at all times. Therefore, before connecting the device to power and communication interfaces (listed below), you must earth the device.

- Connecting to the IP/Ethernet network (refer to 'Connecting to IP Network' on page 19)
- (Optional) Connecting the FXS/FXO interfaces (refer to 'Connecting to FXS/FXO Interfaces' on page 20)
- (Optional) Connecting the analog Lifeline telephone (refer to 'Cabling to Analog Lifeline Phone' on page 21)
- (Optional) Connecting the BRI ports (refer to 'Connecting to ISDN BRI Lines' on page 22) - applicable only to SIP
- (Optional) Connecting the E1/T1 trunks (refer to 'Connecting to E1/T1 Trunks' on page 23)
- (Optional) Connecting the E1/T1 trunks for PSTN Fallback (refer to 'Connecting to E1/T1 Trunks for PSTN Fallback' on page 24)
- (Optional) Connecting the Dry Contact Relay Alarm System (refer to 'Connecting to Dry Contact Relay Alarm System' on page 25)
- (Optional) Connecting to a PC for serial communication (refer to 'Connecting RS-232 Serial Interface to PC' on page 27)
- Connecting the device to the power supply (refer to 'Connecting to Power' on page 28)

Once you have cabled and powered-up the device, the **POWER** LED on the front panel of the Power Supply module is lit green. Any power supply malfunction results in the LED being off (for a description of the LEDs, refer to 'Monitoring Front-Panel LEDs' on page 57). Once you have cabled the device, you can begin configuring the device (refer to 'Configuring the Device' on page 35).

## 2.4.1 Connecting to Earth (Ground)

The device must be permanently connected to earth (ground), using an equipment-earthing conductor.



### Protective Earthing

The equipment is classified as Class I EN60950 and UL60950 and must be earthed at all times.

➤ **To earth the device:**

1. Connect an electrically earthed strap of 16 AWG wire (minimum) to the chassis' earthing screw (located on the rear panel), using the supplied washer.
2. Connect the other end of the strap to a protective earthing. This should be in accordance with the regulations enforced in the country of installation.

**Figure 2-6: Earthing the Device**



## 2.4.2 Connecting to the IP Network

The device's CPU module provides two 10/100Base-TX RJ-45 ports for connectivity to the Ethernet network (IP network). The dual ports provide Ethernet redundancy.

➤ **To connect the device to the IP/Ethernet network:**

1. On the CPU module, connect the first Ethernet port (labeled I) directly to the Ethernet network, using a straight-through RJ-45 Ethernet cable.
2. Optionally, for Ethernet redundancy, connect the second Ethernet port (labeled II) to the Ethernet network.

The RJ-45 connector pinouts are shown in the figure below:

**Figure 2-7: RJ-45 Connector Pinouts**

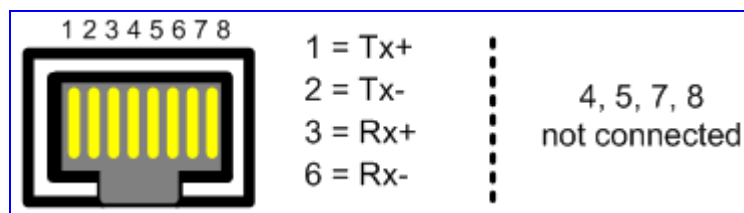

**Notes:**

- For Ethernet redundancy, it's recommended to connect each of the Ethernet ports to a different switch.
- When assigning an IP address to the device using HTTP (refer to 'Assigning an IP Address Using HTTP' on page 35), you may be required to cable the Ethernet port differently.

### 2.4.3 Connecting to FXS/FXO Interfaces

The procedure below describes the cabling of the device's FXS and FXO module analog interfaces.

**Warnings:**

- To protect against electrical shock and fire, use a 26 AWG min wire to connect FXO ports to the PSTN.
- Ensure that FXS and FXO ports are connected to the appropriate, external devices; otherwise, damage to the device can occur.

➤ **To connect the FXS /FXO interfaces:**

- Using the device's RJ-11 connectors on the FXS/FXO module, connect the device to the required telephone interfaces:
  - **FXS:** connect the FXS module's ports to fax machines, modems, and/or telephones.
  - **FXO:** connect the FXO module's ports to telephone exchange analog lines or PBX extensions.

The RJ-11 connector pinouts are shown in the figure below:

**Figure 2-8: RJ-11 Connector Pinouts**

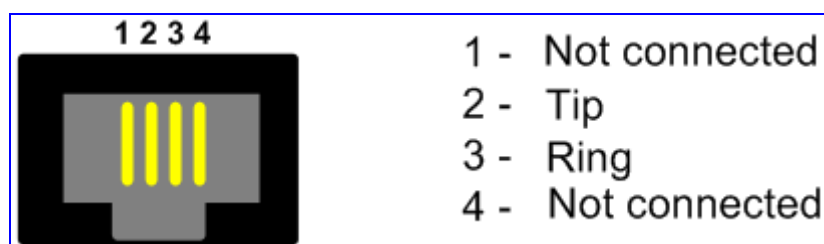

### 2.4.4 Connecting the Analog Lifeline Phone

The device's FXS modules provide a Lifeline phone connection on **Port I**. The Lifeline provides a wired analog POTS phone connection to any PSTN or PBX, which provides PSTN connectivity upon a power outage or when the network connection fails. For each FXS module installed in the device, you can configure one Lifeline phone connection (using Port I).

**Notes:**

- Analog Lifeline is supported only by the FXS modules.
- The Lifeline feature activated upon network failure can be disabled using the LifeLineType *ini* file parameter (described in the device's *User's Manual*).

➤ **To cable the FXS module's Lifeline:**

1. Connect the Lifeline Splitter (supplied) to Port I on the device's FXS module.
2. Connect the Lifeline phone to Port A on the Lifeline Splitter.
3. Connect an analog PSTN line to Port B on the Lifeline Splitter.

The Lifeline splitter connects pins 1 and 4 to another source of an FXS port, and pins 2 and 3 to the POTS phone, as shown in the figure below.

**Figure 2-9: RJ-11 Connector Pinouts for FXS Lifeline**

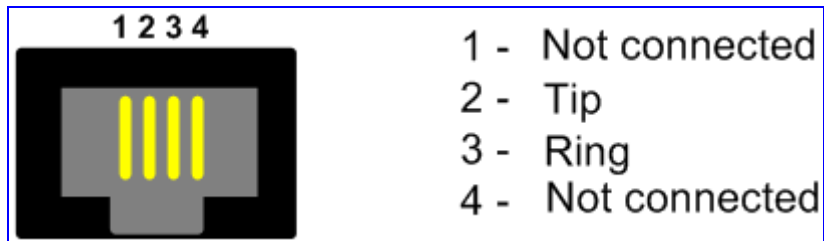

**Figure 2-10: Mediant 1000 Analog Lifeline Cable Setup**

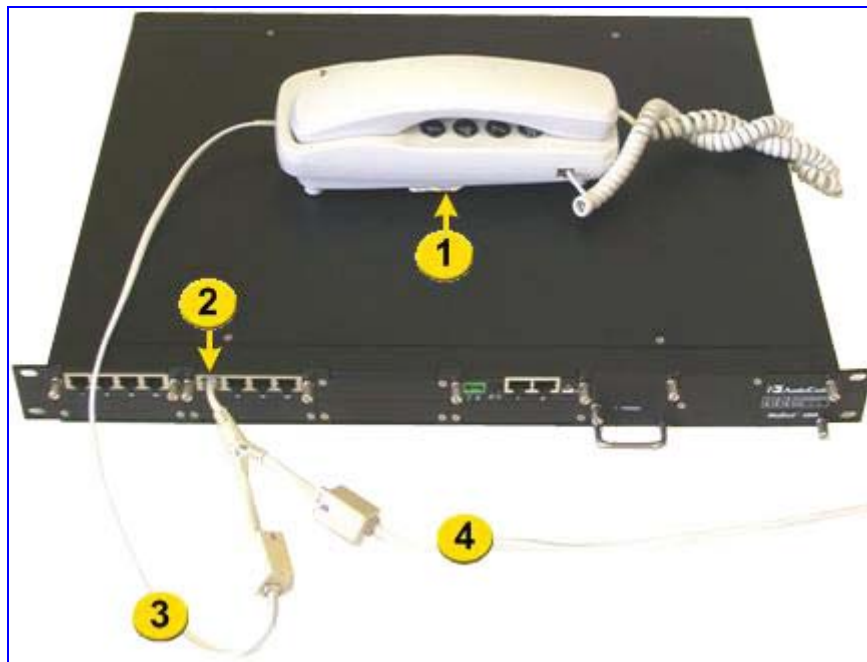

**Table 2-3: FXS Lifeline Setup Component Descriptions**

Item #	Component Description
1	Lifeline phone.
2	Lifeline connected to FXS module Port I.
3	Splitter (A) to Lifeline phone.
4	Splitter (B) to PSTN or PBX extension analog line.

## 2.4.5 Connecting to ISDN BRI Lines

The device can house up to five BRI modules, each supporting four BRI ports, thereby providing a total of up to 20 BRI ports.



**Warning:** To protect against electrical shock and fire, use a 26 AWG min wire to connect the BRI ports to the PSTN.

➤ **To connect the BRI ports:**

1. Connect the BRI cable to the device's BRI RJ-45 port.
2. Connect the other end of the cable to your ISDN telephone or PBX/PSTN switch.

A BRI port can be configured either as TE (Termination Equipment/user side) or NT (Network Termination/network side). The connector pinouts vary according to the configuration, as detailed in the following figure:

**Figure 2-11: RJ-45 Connector Pinouts for BRI Ports**

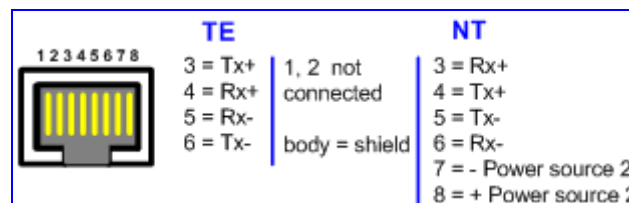

When configured as NT, the BRI port drives a nominal voltage of 38 V with limited current supply of up to 100 mA. The voltage is of Power Source 1 type (line voltage). Power Source 2 is optional.

## 2.4.6 Connecting to E1/T1 Trunks

The procedure below describes the cabling of the device's TRUNKS module interfaces (i.e., E1/T1 trunks).



**Warning:** To protect against electrical shock and fire, use a 26 AWG min wire to connect T1 or E1 ports to the PSTN.

➤ **To connect the digital trunk interfaces:**

1. Connect the E1/T1 trunk cables to the ports on the device's **TRUNKS** module(s).
2. Connect the other ends of the trunk cables to your PBX/PSTN switch.

RJ-48c trunk connectors are wired according to the figure below:

**Figure 2-12: RJ-48c Connector Pinouts for E1/T1**

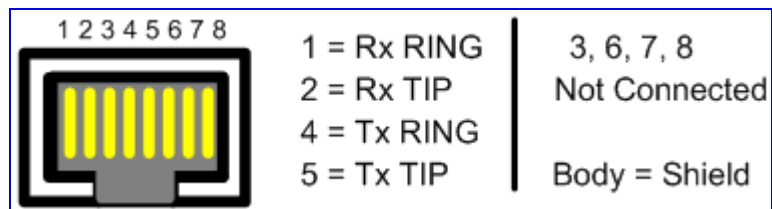

## 2.4.7 Connecting to E1/T1 Trunks for PSTN Fallback

PSTN fallback is supported when the device houses one or two TRUNKS modules, each providing two or four spans. In the event of a power failure, a relay connects trunks 1 to 2, and/or trunks 3 to 4 of the same module. The link is provided by the closing of a metallic switch inside the module so that the Trunk from the PBX is routed from the module to the PSTN.

**Figure 2-13: Mediant 1000 Digital Lifeline Cabling (e.g., Trunks 1 and 2)**

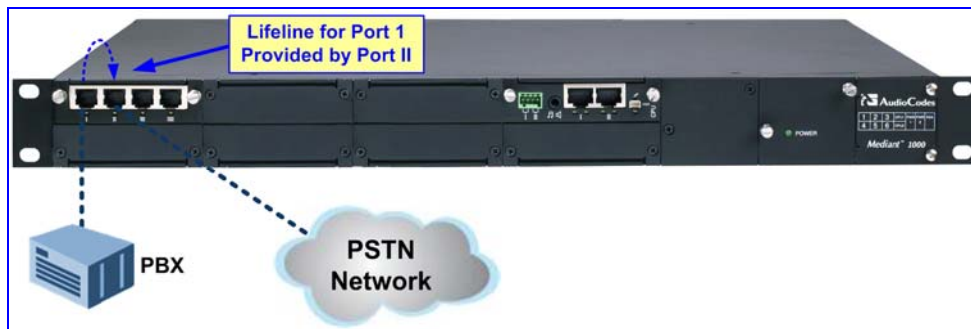

➤ **To connect the digital trunk interfaces for 1+1 or 2+2 PSTN Fallback:**

- On the same TRUNKS module, connect Trunk 1 and Trunk 3 to your PBX, and Trunk 2 and Trunk 4 to the PSTN.



**Notes:**

- PSTN Fallback is supported only between ports on the same TRUNKS module.
- PSTN Fallback is supported only for ISDN when the number of supported channels (e.g., 30) is less than the maximum number of possible channels provided by the physical ports (e.g., two E1 trunks). When the number of supported channels (e.g., 60) equals the maximum number of channels provided by the physical ports (e.g., two E1 trunks), then other protocols such as CAS are also supported.
- This PSTN Fallback feature has no relation to the PSTN Fallback Software Upgrade Key.

## 2.4.8 Connecting to Dry Contact Relay Alarm System

The dry contact ports I and II located on the device's CPU module, allows you to connect the device to an external audible or visual alarm system. The table below describes the operational status of these dry contact ports.

**Table 2-4: Dry Contact Operational Description**

Port	Normal State	Alarm Severity State
I	During normal operation, the dry contact is open.	If a Major alarm is generated, the dry contact closes.
II	During normal operation, the dry contact is closed.	If a Critical alarm is generated, the dry contact opens.

The external alarm system is connected to the device's dry contact connector on the CPU module, using the supplied dry contact wires' mate (refer to the figure below). The mate provides four spring-cage terminal block connector labeled 4, 3, 2 and 1 (from left to right). These connections correspond to the four pins of the dry contact connector on the CPU module.

**Figure 2-14: Dry Contact Wires' Mate**

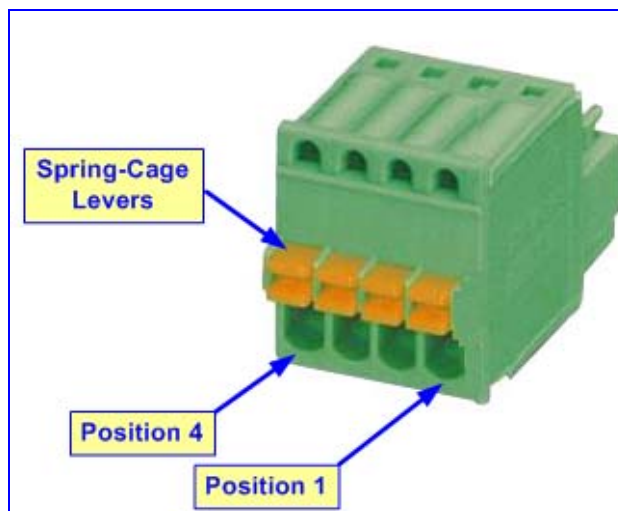

You need to supply your own wiring (for connecting to the mate's spring-cage connections) as well as a visual and/or audible alarm system attached at the other end of the wires. The dry contact connector suites wire sizes in the range 20 to 28 AWG. In addition, the dry contact system can receive a current of up to 1.5 A.



**Note:** The dry contact alarm provided on the CPU must be connected only to SELV (Safety Extra-Low Voltage) non-energy hazard sources (Class 2) as per UL 60950 and EN 60950.

➤ **To set up a dry contact system:**

1. Insert two wires into the mate's spring-cage wire connectors in position 4 and 3 for the device's dry contact Port I, and two wires in position 2 and 1 (for the device's dry contact Port II), by performing the following:
  - a. With a sharp, pointed object, press the position's corresponding orange button; the cage of the connection opens.
  - b. Insert the wire into the connector, and then release the orange button; the cage closes, securing the wire in place.
2. Connect the other ends of the dry contact wiring to the alerts system (alarm, siren, or light) according to your preferences and requirements.

## 2.4.9 Connecting RS-232 Serial Interface to PC

The device's RS-232 interface port is used to access the CLI for serial communication and to receive error/notification messages. A 9-pin DB adaptor cable is supplied for connecting this port to a PC, as described in the procedure below.

➤ **To connect the device's serial interface port to a PC:**

1. Connect one end of the crossover RS-232 cable (supplied) to the device's RS-232 port (located on the CPU module and labeled I0I0).
2. Connect the other end of the crossover RS-232 cable (i.e., the DB-9 connector) to either the COM1 or COM2 RS-232 communication port of your PC.

**Figure 2-15: RS-232 Cable Adaptor**

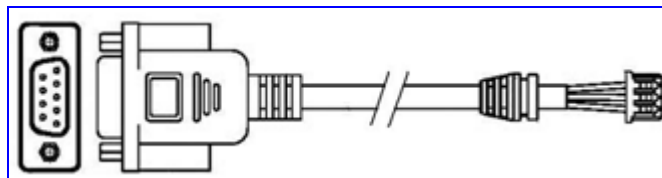

**Notes:**

- The RS-232 port is not intended for permanent connection.
- CLI configuration is currently not supported.

## 2.4.10 Connecting to Power

The device can house up to two extractable power supply modules (Power 1 and Power 2), each providing an AC power connector on the device's rear panel. The dual power option provides the device with power redundancy.

**Figure 2-16: Power Supply Module**

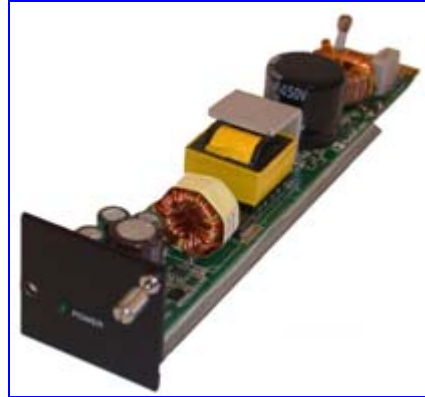

**Warnings:**

- Units must be connected (by service personnel) to a socket-outlet with a protective earthing connection.
- Use only the AC power cord supplied with the device.

➤ **To connect the device to the power supply:**

- On the device's rear panel, connect the left (active) 100-240V~50-60 Hz power socket to a standard electrical outlet using the supplied AC power cord.

The front panel of the power supply module provides a LED (labeled **POWER**) that is lit green when the device is powered up. If this LED is off, a power supply problem may be present.



**Notes:**

- If both power units are used (for load sharing - failure protection/redundancy), ensure that you connect each power supply unit to a different AC supply circuit.
- The two AC power sources must have the same ground potential.

## 2.5 Maintenance

This section describes the following maintenance operations:

- Guidelines for I/O module slot assignment (refer to 'I/O Module Slot Assignment' on page 29)
- Replacing modules (refer to 'Replacing Modules' on page 30)
- Inserting additional modules (refer to 'Inserting Modules into Previously Empty Slots' on page 31)
- Replacing the Fan Tray module (refer to 'Replacing the Air Filter' on page 32)



**Note:** Cover all unoccupied module slots in the front and rear panels of the chassis with blank panels to maintain optimal internal airflow pressure within the chassis.

### 2.5.1 I/O Module Slot Assignment

The device's front-panel chassis provides slots (numbered as shown in the figure below) for housing the main input/output (I/O) interface modules (i.e., TRUNKS, BRI, FXS, FXO, and MPM).

**Figure 2-17: Mediant 1000 Front Layout**

<b>Slot #1</b> I/O Module	<b>Slot #2</b> I/O Module	<b>Slot #3</b> I/O Module	Main CPU	Spare Power Supply Slot	Main Power Supply Unit	Fan Tray Unit
<b>Slot #4</b> I/O Module	<b>Slot #5</b> I/O Module	<b>Slot #6</b> I/O or MPM Module	Spare CPU Slot			

The guidelines for slot assignment for these modules, include the following:

- The TRUNKS, BRI, FXS, and FXO modules must be housed in consecutive slots. In other words, if the device houses three modules, then they must occupy slots 1, 2, and 3 (no skipping of slots).
- It is recommended to assign the TRUNKS, BRI, FXS, and FXO modules to the slots (starting from Slot 1) according to the order of priority listed below:
  1. TRUNKS
  2. BRI
  3. FXS and/or FXO

For example, if the device requires one TRUNKS module and two FXS modules, then you must insert the TRUNKS module in Slot 1 and the two FXS modules in slots 2 and 3 respectively. If at a later stage, you wish to add a BRI module (for example), then you must replace the FXS module in Slot 2 with the new BRI module, and then re-insert this replaced FXS module in Slot 4. The figure below displays an example illustration of correct module slot assignment:

**Figure 2-18: Recommended Priority Module Slot Assignment**

<b>Slot #1</b> TRUNKS Module	<b>Slot #2</b> TRUNKS Module	<b>Slot #3</b> BRI Module	Main CPU	Spare Power Supply Slot	Main Power Supply Unit	Fan Tray Unit
<b>Slot #4</b> FXO Module	<b>Slot #5</b> FXS Module	<b>Slot #6</b> MPM Module	Spare CPU Slot			

- The MPM module provides IP media channels for applications such as announcements, conferencing, and IP-to-IP call routing:
  - When no other modules are used, up to three MPM modules can be housed in the device.
  - For conferencing, one MPM module must be housed in Slot 6, providing 20 media channels. For additional media channels, you can add MPM modules to slots 4 (40 channels) and 5 (40 channels) as well, thereby providing a total of 100 media channels for conferencing.
  - For applications other than conferencing (e.g., IP-to-IP routing and announcements), the MPM modules can be housed in slots 3, 4, and 5. Each module provides 40 channels, therefore, providing a total of 120 channels (60 for IP-to-IP call sessions).
  - The device can acquire additional media channel resources (for IP-to-IP routing and conferencing) from the TRUNKS modules. For a description of this configuration, refer to the device's *User's Manual*.

## 2.5.2 Replacing Modules

The device's I/O modules are hot-swappable (except for the OSN Server modules). The physical replacement of the TRUNKS, FXS, and FXO modules is performed together with a software replacement procedure performed in the device's Web interface. Once you have 'software-removed' the module, you can then physically remove the module and replace it with a new module. Once the new module is inserted in the chassis slot, you then need to 'software-insert' it.



### Warnings:

- Replace damaged modules with the identical module type and in the exact chassis slot. For example, a TRUNKS module with two digital spans in Slot 1 must be replaced with a TRUNKS module with two digital spans in Slot 1.
- When only one I/O module remains in the chassis, removal of this last module causes the device to reset.

➤ **To replace I/O modules:**

1. Software-remove the module, using the device's Web interface's 'Home' page (refer to the device's *User's Manual*).
2. Disconnect the cables from the module that you want to replace.
3. Physically remove the module from the device's front-panel slot, by performing the following:
  - a. Using a flathead screwdriver, loosen the module's two mounting screws.
  - b. Gently extract the module from the slot.
4. Physically insert the new module into the same slot from where the module that you are replacing resided, by performing the following:
  - a. Insert the module into the empty slot, with the orientation of the module as follows:
    - ◆ **Top-row slots:** ensure that the module is orientated such that the port number labels are located at the bottom of the module's front panel. This module orientation is considered as facing up.
    - ◆ **Bottom-row slots:** ensure that the module is orientated such that the port number labels are located at the top of the module's front panel. This module orientation is considered as facing down.

**Figure 2-19: Module Orientation in Chassis Top- and Bottom-Row Slots**



- b. Align the module with the slot rails.
  - c. Gently push the module into the slot and press on it firmly to ensure it has been fully inserted.
  - d. Using a flathead screwdriver, tighten the module's mounting pins.
5. Reconnect the cables to the module
6. Software-insert the module, using the device's Web interface's 'Home' page (refer to the device's *User's Manual*).

## 2.5.3 Inserting Modules into Previously Empty Slots

The procedure below describes how to add additional I/O modules to previously empty slots in the device's chassis.



**Warning:** Ensure that you power down the device before adding a module to a previously empty slot.

### ➤ To install a module into a previously empty slot:

1. Power off the device.
2. On the device's front panel, using a Phillips screwdriver, remove the black metal cover plate protecting the module slot.
3. Insert the required module into the empty slot, aligning the module with the rails in the slot in the following module orientation depending on whether you are inserting it in the top- or bottom-row slots:
  - **Top-row slots:** ensure that the module is orientated such that the port number labels are located at the bottom of the module's front panel. This module orientation is considered as facing up.
  - **Bottom-row slots:** ensure that the module is orientated such that the port number labels are located at the top of the module's front panel. This module orientation is considered as facing down.
4. Push the module into the slot and press on it firmly to ensure it has been fully inserted.
5. Using a flathead screwdriver, tighten the module's mounting pins.
6. Power on the device.

## 2.5.4 Replacing the Air Filter

The Fan Tray module includes six integrated fans, which cool the device's internal components. The Fan Tray module draws in air through a perforated grill on the right side of the chassis. The incoming air passes through an air filter, whose honeycombed design prevents radio frequency (RF) interference. The filtered air passes through the entire set of modules, cooling each one, and then exits the device through perforated vents on the left side of the chassis.

The Fan Tray module includes a removable air filter (located within the fan assembly, immediately inside the perforated grill). The air filter should be replaced approximately every three months and should be checked weekly to ensure that it is not saturated and that it does not require cleaning/replacement. You should clean the air filter no more than three times, after which the air filter should be replaced. Cleaning or replacing the air filter can be carried out while the system is fully functioning.



### Warnings:

- When removing the Fan Tray module while the power is on (or after it has recently been switched off), the blades may still be rotating at high speeds. Therefore, to avoid bodily harm ensure that you don't touch the fan blades.
- Before removing the Fan Tray module for cleaning the air filter, prepare all the required equipment. It is imperative that the chassis does not remain without the Fan Tray module for a lengthy period. Ensure that you re-insert the Fan Tray module (without the air filter) while you are cleaning the air filter, and then re-insert the air filter as soon as it is clean.

### ➤ To clean/replace the air filter:

1. Release the two screws on the top right-hand corner and the bottom right-hand corner of the front panel of the Fan Tray module.
2. Pull the Fan Tray module outward. The figure below shows the Fan Tray module slightly extracted.

**Figure 2-20: Slightly Extracted Fan Try Unit**

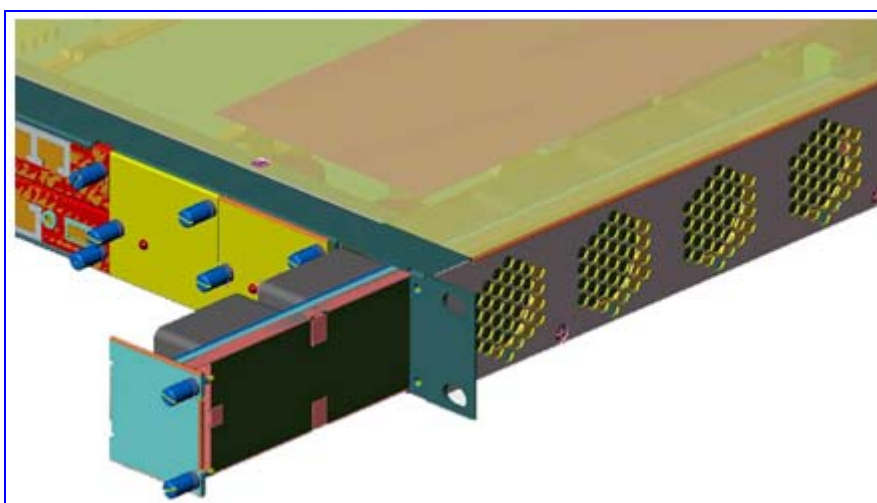

3. With your fingertips, grasp the steel frame of the air filter and separate it from the Fan Tray module; you should be able to remove it relatively easily. The figure below shows the air filter extracted from the Fan Tray module.

**Figure 2-21: Fan Tray with Filter Removed**

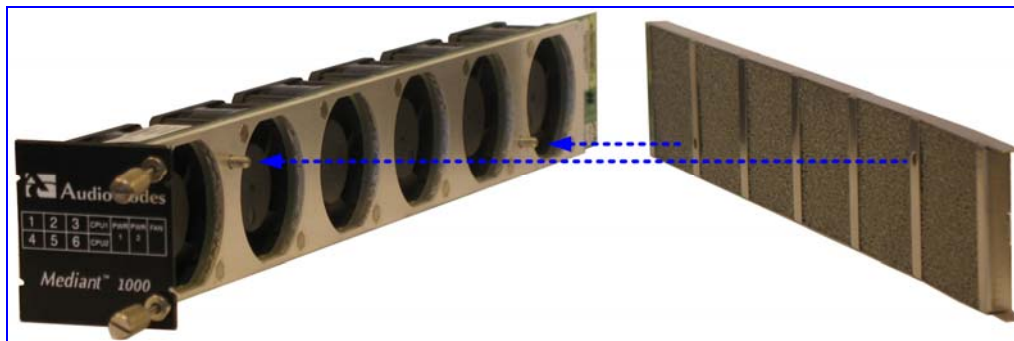

4. Take one of the following steps:
  - If you are cleaning the filter, use a vacuum cleaner (set to light suction) to remove dust particles from the filter.
  - If you are replacing the filter, discard the old air filter and replace it with an air filter purchased from AudioCodes.
5. Attach the (new or cleaned) air filter to the Fan Tray module; position the two holes on the filter over the pins on the Fan Tray.
6. Insert the Fan Tray module into its slot, until the front panel is flush with the chassis plate.
7. Fasten the two screws on the top right-hand corner and the bottom right-hand corner of the front panel of the Fan Tray module.

## 3 Configuring the Device

This section describes initial, basic setup configuration for the device, using the device's embedded Web server (*Web interface*).



### Notes:

- The device is supplied with application software (cmp file) already residing on its flash memory. This software is set to factory defaults.
- If necessary, you can restore the device to factory defaults (refer to 'Restoring Factory Default Settings' on page 50).

### 3.1 Assigning an IP Address

This section describes how to change the device's default IP address so that it corresponds with your network environment. The table below lists the device's default IP address.

**Table 3-1: Default IP Addresses**

Parameter	Default Value
IP Address	10.1.10.10
Subnet Mask	255.255.0.0
Default Gateway IP Address	0.0.0.0

To assign an IP address to the device, use one of the following methods:

- Device's HTTP-based embedded Web server `accessed using a Web browser (refer to 'Assigning an IP Address using HTTP' on page 35).
- BootP (refer to 'Assigning an IP Address using BootP' on page 37).
- Voice Menu using a standard touch-tone telephone connected to one of the FXS analog ports (refer to 'Assigning an IP Address using the Voice Menu Guidance' on page 38).
- Embedded Command Line Interface (CLI), accessed using RS-232 or Telnet (refer to 'Assigning an IP Address using the CLI' on page 41).
- Dynamic Host Control Protocol (DHCP) - refer to the *User's Manual*.



**Tip:** If at a later stage after re-defining the IP address, your IP address is unknown (e.g., forgotten), use the BootP/TFTP utility to access the device (refer to the Product Reference Manual).

### 3.1.1 Assigning an IP Address using HTTP

You can assign an IP address to the device, using the device's Web interface.

➤ **To assign an IP address using HTTP:**

1. Disconnect the device from the network and reconnect it to a PC using one of the following methods:
  - **Using a hub or switch between a PC and the device:** Connect the network interface on your PC to a port on a network hub / switch, using a standard Ethernet cable. Connect the device to another port on the same network hub / switch, using another standard Ethernet cable.
  - **Direct connection between a PC and the device:** Connect the network interface on your PC directly to the device, using an Ethernet crossover cable.
2. Change your PC's IP address and subnet mask to correspond with the device's factory default IP address and subnet mask (for default IP addresses, refer to Assigning an IP Address on page 35).
3. Access the device's Web interface:
  - a. Open a standard Web browser application and in the Uniform Resource Locator (URL) field, enter the device's default IP address (e.g., `http://10.1.10.10`); the Web interface's 'Enter Network Password' dialog box appears, as shown in the figure below:

**Figure 3-1: Enter Network Password Screen**

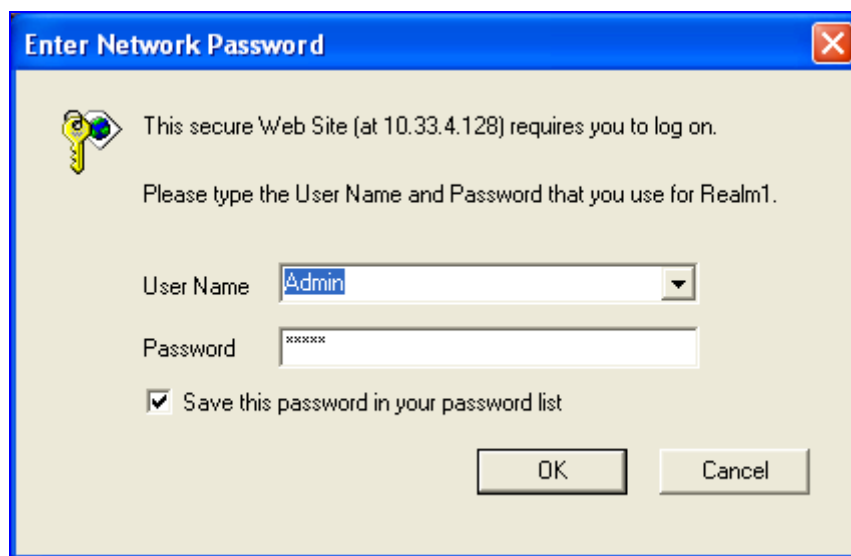

- b. Enter the device's default login, case-sensitive user name ('Admin') and password ('Admin'), and then click **OK**; the Web interface is accessed, displaying the Web interface's 'Home' page.



**Note:** To prevent unauthorized access to the device, it's recommended that after you initially access the Web interface to change the default login user name and password (refer to Changing the Login User Name and Password on page 47).

4. Change the device's IP address, by performing the following:
  - a. Open the 'Multiple Interface Table' page, (**Configuration** tab > **Network Settings** menu > **IP Settings**).
  - b. Define the device's IP address, subnet mask, and default Gateway IP address (for "OAMP + Media + Control" application type) so that they correspond to your network IP scheme.
  - c. Click **Apply**.
  - d. Save your settings to the flash memory and reset the device (refer to 'Saving and Resetting the Device' on page 46).
5. Disconnect your PC from the device or from the hub/switch (depending on the connection method used in Step 1).
6. Reconnect the device and PC (if necessary) to the network.
7. Restore your PC's IP address and subnet mask to their original settings. If necessary, restart your PC and re-access the device via the Web interface with its newly assigned IP address.

### 3.1.2 Assigning an IP Address using BootP

You can assign an IP address to the device, using the supplied AudioCodes' BootP/TFTP Server application.



#### Notes:

- BootP procedure can also be performed using any standard compatible BootP server.
- For a detailed description of BootP, refer to the *Product Reference Manual*.

#### ➤ To assign an IP address using BootP:

1. Start the BootP application.
2. From the Edit menu, choose **Preferences**, and then in the 'Preferences' dialog box, set the 'Timeout' field to 50.
3. From the Services menu, choose **Clients**; the 'Client Configuration' dialog box appears.
4. Click the **Add New Client**  icon; a client with blank parameters is displayed.
5. In the 'Client MAC' field, enter the device's MAC address. The MAC address is printed on the label located on the underside of the device. Ensure that the check box to the right of the field is selected - this enables the client in the BootP tool (if the client is disabled, no replies are sent to BootP requests).
6. In the 'IP' field, enter the IP address (in dotted-decimal notation) that you want to assign to the device.
7. In the 'Subnet' field, enter the subnet mask (in dotted-decimal notation) that you want to assign to the device. Ensure that the subnet mask is valid, otherwise, the device may not function.
8. In the 'Gateway' field, enter the IP address of the default gateway (if any).

9. Click **Apply** to save the new client.
10. Click **OK**; the 'Client Configuration' screen closes.
11. Physically reset the device using the hardware reset button (or power down and then power up the device). This causes the device to use BootP; the device changes its network parameters to the values provided by BootP.

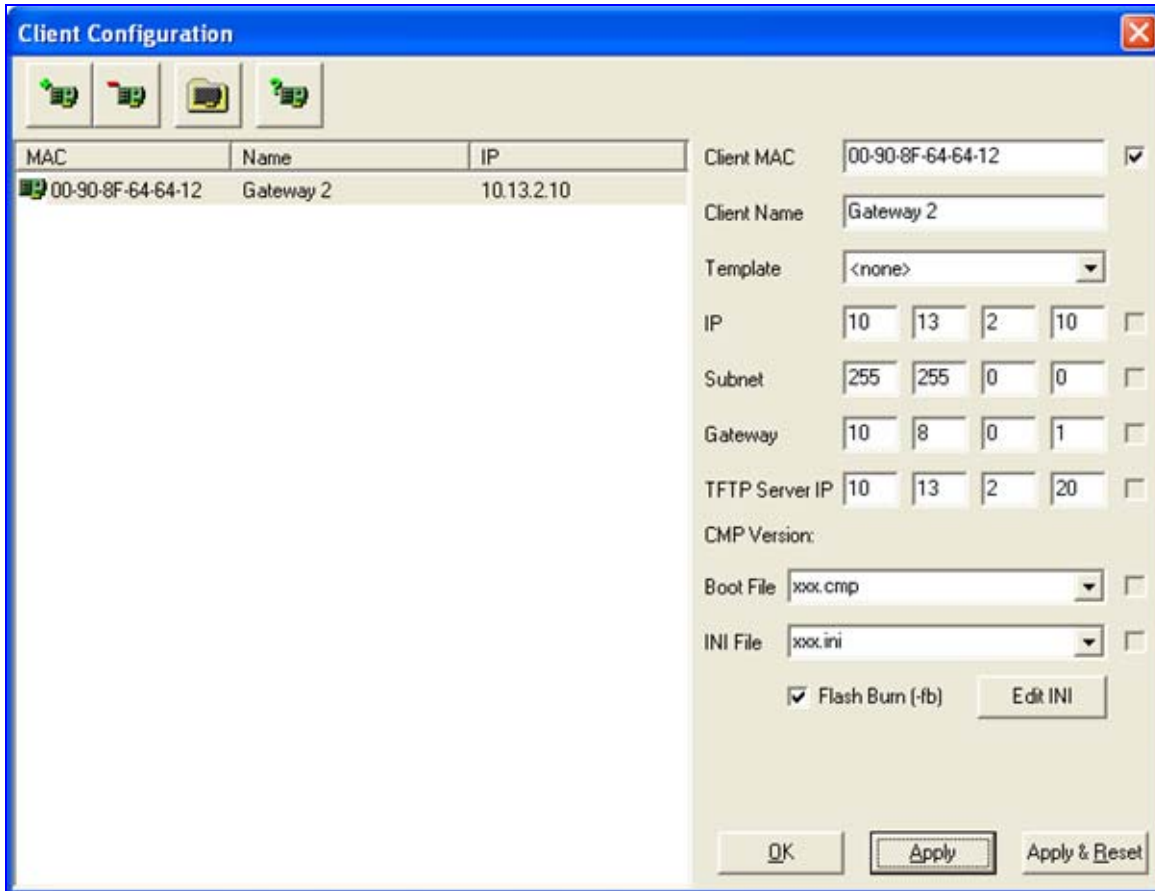
**Figure 3-2: BootP Client Configuration Screen**

The screenshot shows the 'Client Configuration' window. On the left, there is a table with columns for MAC, Name, and IP. The table contains one entry: MAC 00-90-8F-64-64-12, Name Gateway 2, and IP 10.13.2.10. On the right, there are configuration fields for Client MAC (00-90-8F-64-64-12), Client Name (Gateway 2), Template (<none>), IP (10.13.2.10), Subnet (255.255.0.0), Gateway (10.8.0.1), TFTP Server IP (10.13.2.20), CMP Version, Boot File (xxx.cmp), and INI File (xxx.ini). There are also checkboxes for 'Flash Burn (-fb)' and 'Edit INI', and buttons for 'OK', 'Apply', and 'Apply & Reset'.

MAC	Name	IP
00-90-8F-64-64-12	Gateway 2	10.13.2.10

### 3.1.3 Assigning an IP Address using the Voice Menu Guidance

Initial configuration of the device can be performed using a standard touch-tone telephone connected to one of the FXS ports. The voice menu can also be used to query and modify basic configuration parameters.



**Note:** Assigning an IP address using voice menu guidance is only relevant when the device houses an FXS module.

➤ **To assign an IP address using the voice menu guidance:**

1. Connect a telephone to one of the FXS ports.
2. Lift the handset and dial **\*\*\*12345** (three stars followed by the digits 1, 2, 3, 4, and 5).
3. Wait for the 'configuration menu' voice prompt to be played.

4. To change the IP address:
  - a. Press **1** followed by the pound key (**#**); The current IP address of the device is played.
  - b. Press the **#** key.
  - c. Dial the new IP address. Use the star (\*) key instead of periods (.), e.g., 192\*168\*0\*4, and then press **#** to finish.
  - d. Review the new IP address, and then press **1** to save.
5. To change the subnet mask:
  - a. Press **2** followed by the **#** key; The current subnet mask of the device is played.
  - b. Press the **#** key.
  - c. Dial the new subnet mask (e.g., 255\*255\*0\*0), and then press **#** to finish.
  - d. Review the new subnet mask, and then press **1** to save.
6. To change the default Gateway IP address:
  - a. Press **3** followed by the **#** key; The current default Gateway address is played.
  - b. Press the **#** key.
  - c. Dial the new default Gateway address (e.g., 192\*168\*0\*1), and then press **#** to finish.
  - d. Review the new default Gateway address, and then press **1** to save.
7. Hang up the handset.
8. Access the device's Web interface with the new IP address you assigned.

Alternatively, initial configuration may be performed using an HTTP server, as discussed in the *Product Reference Manual* ('Automatic Update Facility'). The Voice Menu may be used to specify the configuration URL.

➤ **To set a configuration URL:**

1. Obtain the IP address of the configuration HTTP server (e.g., 36.44.0.6).
2. Connect a telephone to one of the FXS ports.
3. Lift the handset and dial **\*\*\*12345** (three stars followed by the digits 1, 2, 3, 4, and 5).
4. Wait for the 'configuration menu' voice prompt to be played.
5. Dial **31** followed by the **#** key; the current IP address is played.
6. To change the IP address, perform the following:
  - a. Press the **#** key.
  - b. Dial the configuration server's IP address. Use the star (\*) key instead of dots ("."), e.g., 36\*44\*0\*6, and then press **#** to finish.
  - c. Review the configuration server's IP address, and then press **1** to save.

7. Dial **32** followed by the **#** key, and then perform the following to change the configuration file name pattern:
  - a. Press the **#** key.
  - b. Select one of the patterns listed in the table below (*aa.bb.cc.dd* denotes the IP address of the configuration server):

#	Configuration File Name Pattern	Description
1	http://aa.bb.cc.dd/config.ini	Standard config.ini.
2	https://aa.bb.cc.dd/config.ini	Secure HTTP.
3	http://aa.bb.cc.dd/audiocodes/<MAC>.ini	The device's MAC address is appended to the file name (e.g., http://36.44.0.6/audiocodes/00908f012300.ini).
4	http://aa.bb.cc.dd:8080/config.ini	HTTP on port 8080.
5	http://aa.bb.cc.dd:1400/config.ini	HTTP on port 1400.
6	http://aa.bb.cc.dd/cgi-bin/acconfig.cgi?mac=<MAC>&ip=<IP>	Generating configuration per IP/MAC address dynamically, using a CGI script. See perl example below.

- c. Press the selected pattern code, and then press **#** to finish.
8. Press **1** to save, and then hang up the handset. The device retrieves the configuration from the HTTP server.

The following is an example perl CGI script, suitable for most Apache-based HTTP servers for generating configuration dynamically per pattern #6 above. Copy this script to `/var/www/cgi-bin/acconfig.cgi` on your Apache server and edit it as required:

```
#!/usr/bin/perl
use CGI;
$query = new CGI;
$mac = $query->param('mac');
$ip = $query->param('ip');
print "Content-type: text/plain\n\n";
print "; INI file generator CGI\n";
print "; Request for MAC=$mac IP=$ip\n\n";
print <<"EOF";

SyslogServerIP = 36.44.0.15
EnableSyslog = 1
SSHServerEnable = 1

EOF
```

The table below lists the configuration parameters that can be queried or modified using the voice menu:

**Table 3-2: Configuration Parameters Available via the Voice Menu**

Item Number at Menu Prompt	Description
<b>1</b>	IP address.
<b>2</b>	Subnet mask.
<b>3</b>	Default Gateway IP address.

Item Number at Menu Prompt	Description
4	Primary DNS server IP address.
7	DHCP enable / disable.
31	Configuration server IP address.
32	Configuration file name pattern.
99	Voice menu password (initially 12345). <b>Note:</b> The voice menu password can also be changed using the Web interface or <i>ini</i> file parameter VoiceMenuPassword (refer to the <i>User's Manual</i> ).

### 3.1.4 Assigning an IP Address Using the CLI

You can assign an IP address to the device, using command-line interface (CLI).

➤ **To assign an IP address via the CLI:**

1. Connect the device's RS-232 port to either COM1 or COM2 communication port on your PC (refer to 'Connecting the RS-232 Port to a PC' on page 27).
2. Use a serial communication software (e.g., HyperTerminal™) to establish a serial communication link with the device, using the following communications port settings:

- **Baud Rate:** 115,200 bps
- **Data Bits:** 8
- **Parity:** None
- **Stop Bits:** 1
- **Flow Control:** None

The CLI prompt appears.

3. At the prompt, type `conf`, and then press <Enter>; the configuration folder is accessed.
4. To view the current network parameters, at the prompt, type `GCP IP`, and then press <Enter>; the current network settings are displayed.
5. Change the network settings by typing the following:

```
SCP IP [ip_address] [subnet_mask] [default_gateway]
```

For example,

```
SCP IP 10.13.77.7 255.255.0.0 10.13.0.1
```

The new settings take effect on-the-fly and connectivity to the device is active at the new IP address.

**Note:** This command requires you to enter all three network parameters (each separated by a space).

6. To save the configuration, at the prompt, type `SAR`, and then press <Enter>; the device restarts with the new network settings.

## 3.2 Configuring Basic SIP Parameters

Once you have completed the previous sections, you are ready to start configuring the device using the Web interface. For information on how to fully configure the device, refer to the device's *User's Manuals*.

➤ **To configure basic SIP parameters:**

1. Access the Web interface.
2. Select the voice coders used by the device that best suits your VoIP network in the 'Coders Table' page (**Configuration** tab > **Protocol Configuration** menu > **Coders And Profile Definitions** submenu > **Coders**).
3. When operating with a Proxy server, perform the following (otherwise, skip to Step 4):
  - a. In the 'Proxy & Registration' page (**Configuration** tab > **Protocol Configuration** menu > **Proxies, Registration, IP Groups** submenu > **Proxy & Registration**):
    - ◆ Set the 'Use Default Proxy' field to "Yes".
    - ◆ (Optional) In the 'Proxy Name' field, enter the Proxy's name. The Proxy name replaces the Proxy IP address in all SIP messages. This means that messages are still sent to the physical Proxy IP address, but the SIP URI contains the Proxy name instead.
    - ◆ To enable the device to register to a Proxy/Registrar server (at power up and every user-defined interval - 'Registration Time' parameter), set the parameter 'Enable Registration' to "Enable".
  - b. In the 'Proxy Sets Table' page (**Configuration** tab > **Protocol Configuration** menu > **Proxies, Registration, IP Groups** submenu > **Proxy Sets Table**), define the IP address(s) of the Proxy server(s). When no Proxy is used, the internal routing table is used to route the calls.
4. Enable the device's channels in the 'Trunk Group Table' page (**Configuration** tab > **Protocol Configuration** menu > **Trunk Group** submenu > **Trunk Group**).
5. Configure the Trunks in the 'Trunk Settings' page (**Configuration** tab > **PSTN Settings** menu > **Trunk Settings**). For a brief description, refer to 'Configuring PSTN Trunks' on page 44.
6. If a Proxy server is not implemented, map outgoing calls to IP addresses in the 'Outbound IP Routing' page (**Configuration** tab > **Protocol Configuration** menu > **Routing Tables** submenu > **Tel to IP Routing**).
7. Save your settings to the flash memory and reset the device (refer to 'Saving and Resetting the Device' on page 46).



**Tip:** Once the device is configured, backup your settings by saving the configuration (*ini*) file to your PC. This saved file can later be used, if necessary, to restore configuration settings (refer to 'Backing Up and Restoring Configuration' on page 49).

### 3.2.1 Enabling Channels and Configuring Call Routing (Example)

This section provides an example for enabling the device's channels and for configuring Tel (PSTN)-to-IP call routing. This includes assigning the channels a telephone number and then routing calls (e.g., of dialed numbers with prefix 10) from these channels to a specific IP destination (e.g., IP address 10.33.24.14).

➤ **To enable channels and configure call routing:**

1. Assign telephone numbers to endpoints or trunk channels, by performing the following:
  - a. Open the 'Trunk Group Table' page (**Configuration** tab > **Protocol Configuration** menu > **Trunk Group** submenu > **Trunk Group**).

**Figure 3-3: Enabling Channels in Trunk Group Table Page**

Group Index	Module	From Trunk	To Trunk	Channels	Phone Number	Trunk Group ID	Tel Profile ID
1	Module 3 FXS	1	1	1-4	101		0
2	Module 5 FXO	2	2	1-4	201	1	0
3	Module 1 PRI	1	1	1-30	11000	2	0
4	Module 2 BRI	2	2	1-2	22000	3	0

- b. Assign telephone numbers to the following interfaces:
  - ◆ **FXS:** In the 'Module' column, select 'Module 3 FXS', enter 1-4 (i.e., channels 1 through 4) in the 'Channel(s)' column, and then in the 'Phone Number' column, enter the phone number (e.g., 101) for the first channel. Phone numbers 102, 103, and 104 are sequentially assigned to subsequent channels (i.e., 2 through 4).
  - ◆ **FXO:** In the 'Module' column, select 'Module 5 FXO', enter 1-4 (i.e., channels 1 through 4) in the 'Channel(s)' column, enter the phone number (e.g., 201) for the first channel in the 'Phone Number' column, and then enter 1 in the 'Trunk Group ID' column. Phone numbers 202, 203, and 204 are sequentially assigned to subsequent channels (i.e., 2 through 4).
  - ◆ **PRI:** In the 'Module' column, select 'Module 1 PRI', select 1 (i.e., trunk 1) in the 'From Trunk' and 'To Trunk' columns, enter 1-30 (i.e., channels 1 through 30) in the 'Channel(s)' column, enter the phone number (e.g., 11000) for the first channel in the 'Phone Number' column, and then enter 2 in the 'Trunk Group ID' column. Phone numbers 11001, 11002, 11003 and so on are sequentially assigned to subsequent channels (i.e., 2 through 30).
  - ◆ **BRI:** In the 'Module' column, select 'Module 2 BRI', select 2 (i.e., trunk 2) in the 'From Trunk' and 'To Trunk' columns, enter 1-2 (i.e., channels 1 through 2) in the 'Channel(s)' column, enter the phone number (e.g., 22000) for the first channel in the 'Phone Number' column, and then enter 3 in the 'Trunk Group ID' column. Phone number 22001 is automatically assigned to the subsequent channel (i.e., 2).
- c. Click **Submit**.

2. Configure routing rules for telephone calls (i.e., Tel or inbound IP) to an IP destination (i.e., IP address):
  - a. Open the 'Outbound IP Routing' page (**Configuration** tab > **Protocol Configuration** menu > **Routing Tables** submenu > **Tel to IP Routing**).

**Figure 3-4: Routing Tel Calls to an IP Address**

	Src. Trunk Group ID	Dest. Phone Prefix	Source Phone Prefix	- >	Dest. IP Address	Port	Transport Type	Dest. IPGroup ID
1		10	10		10.33.24.14		Not Configured	▼
2	1	10	20		10.33.24.14		Not Configured	▼
3	2	10	11		10.33.24.14		Not Configured	▼
4	3	10	22		10.33.24.14		Not Configured	▼

- b. In the 'Src. Trunk Group ID' column, enter the Trunk Group number as defined in Step 1.
- c. In the 'Dest. Phone Prefix' column, enter "10" (i.e., prefix of dialed number).
- d. In the 'Source Phone Prefix' column, enter the prefix of the channel's telephone number as defined in Step 1.
- e. In the 'Dest. IP Address' column, enter 10.33.24.14 (i.e., calls are sent to this IP address).
- f. Click **Submit**.

Therefore, any call whose dialed number prefix matches the value in the 'Dest. Phone Prefix' column (i.e., 10) and whose source phone number prefix matches the value in the 'Source Phone Prefix' column is sent to the IP address defined in the 'Dest. IP Address' column.

### 3.3 Configuring PSTN Trunks

This section describes how to configure the device's E1/T1 PRI and BRI trunks.

➤ **To configure the trunks:**

1. Open the 'Trunk Settings' page (**Configuration** tab > **PSTN Settings** menu > **Trunk Settings**).

**Figure 3-5: Trunk Settings Page**



The screenshot shows the 'Trunk Settings' page. At the top, there is a navigation bar with tabs 1 through 6, and a search bar. Below the navigation bar, the page is divided into two main sections: 'General Settings' and 'Trunk Configuration'.

**General Settings:**

Module ID	1
Trunk ID	1
Trunk Configuration State	<b>Active</b>
Protocol Type	E1 EURO ISDN

**Trunk Configuration:**

Clock Master	Recovered
Auto Clock Trunk Priority	0
Line Code	HDB3
Framing Method	EXTENDED SUPER FRAME

2. Click the **Stop Trunk**  button (located at the bottom of the page) to de-activate the trunk so that you can configure currently grayed out (unavailable) parameters. (Skip this step if you want to configure parameters that are also available when the trunk is active).





**Note:** You cannot stop a trunk if it provides the device's clock (assuming the device is synchronized with the E1/T1 clock). If this is the case, then assign a different E1/T1 trunk to provide the device's clock or enable 'TDM Bus PSTN Auto Clock' in the 'TDM Bus Settings' page.

3. From the 'Protocol Type' drop-down list, select the required protocol.



**Notes:**

- If the 'Protocol Type' field displays 'NONE' (i.e., no protocol type selected) and no other trunks have been configured, after selecting a PRI protocol type, you must reset the device.
- After selecting a PSTN protocol in the 'Protocol Type' field, only the relevant parameters for this protocol are displayed.
- Different protocols (CAS or ISDN variants) can be defined between trunks (subject to the constraints in the device's *Release Notes*).

4. From the 'Framing Method' drop-down list, select the required framing method. For E1 trunks, always set this parameter to 'Extended Super Frame'.
5. From the 'Clock Master' drop-down list, select the trunk's clock source:
  - 'Recovered' = clock source is recovered from the trunk.
  - 'Generated' = clock source is provided by the internal TDM bus clock source (according to the parameter 'TDM Bus Clock Source').
6. From the 'Line Code' drop-down list, select the line code:
  - 'B8ZS' (bipolar 8-zero substitution) for T1 trunks only.
  - 'HDB3' (high-density bipolar 3) for E1 trunks only.
  - 'AMI' (for both T1 and E1).
7. (Applicable only to ISDN protocols.) From the 'ISDN Termination Side' drop-down list, select 'User Side' when the PSTN or PBX side is configured as 'Network side', and vice versa. If the device's ISDN termination side is unknown, choose 'User Side' and then access the 'Home' page. If the D-channel alarm is indicated, choose 'Network Side'.
8. To configure the different ISDN behavior bits, either enter the exact hexadecimal value of the bits in the field to the right of the relevant behavior parameter, or directly configure each bit field by completing the following steps:
  - a. Click the arrow  button to the right of the relevant parameter; the relevant behavior page appears.
  - b. Modify each bit field according to your requirements.
  - c. Click the **Submit** button to save your changes.
9. Click the **Apply Trunk Settings**  button to apply your settings to the trunk.
10. Access the 'TDM Bus Settings' page (**Configuration** tab > **TDM Configuration** menu > **TDM Bus Settings**), and then from the 'PCM Law Select' drop-down list, select 'Alaw' for E1 trunks and 'MuLaw' for T1 trunks.
11. Save the changes to flash memory and reset the device (refer to 'Saving and Resetting the Device' on page 46).

## 3.4 Saving and Resetting the Device

To apply configuration changes to the device's volatile memory (RAM), click the **Submit**



button located on the page in which you are configuring. Modifications to parameters with on-the-fly capabilities are immediately applied to the device; other parameters are applied only after a device reset. However, parameters saved to the volatile memory revert to their previous settings after a hardware or software reset (or if the device is powered down). Therefore, to ensure that all parameter changes (whether on-the-fly or not) are retained, you need to save ('burn') them to the device's non-volatile memory (i.e., flash).

You can also "gracefully lock" the device so that no new calls are allowed and existing calls are terminated only after a user-defined period. This is useful when, for example, you are uploading new software files to the device and you don't want to disrupt existing traffic.



**Note:** Parameters preceded by the lightning ⚡ sign are not changeable on-the-fly and require a device reset.

### ➤ To save parameters to flash memory and reset the device:

1. On the toolbar, click **Device Actions**, and then from the drop-down list, choose **Reset**; the 'Maintenance Actions' page appears.

**Figure 3-6: Maintenance Actions Page**

▼ Reset Configuration	
Reset Board	<b>Reset</b>
Burn To FLASH	Yes <input type="button" value="v"/>
Graceful Option	No <input type="button" value="v"/>
▼ LOCK / UNLOCK	
Lock	<b>LOCK</b>
Graceful Option	No <input type="button" value="v"/>
Current Admin State	UNLOCKED
▼ Save Configuration	
Burn To FLASH	<b>BURN</b>

2. Under the 'Reset Configuration' group, ensure that 'Yes' is selected in the 'Burn to FLASH' drop-down list.
3. (Optional) To gracefully lock the device, click the **LOCK** button, from the 'Graceful Option' drop-down list select 'Yes', and then define the time (in seconds) after which the device locks.
4. Click the **Reset** button.

## 3.5 Changing Login User Name and Password

To prevent unauthorized access to the Web interface, two Web user accounts (login accounts) are available (primary and secondary) with assigned user name and password. For detailed information on the Web user accounts, refer to the device's *User's Manual*.



**Tip:** If you do not know your user name and password, you can use AudioCodes BootP/TFTP utility to access the device, by re-flash the load and resetting the password (refer to the *Product Reference Manual*).

➤ **To change the login user name and password:**

1. Open the 'WEB User Accounts' page (**Configuration** tab > **Security Settings** menu > **WEB User Accounts**).

**Figure 3-7: WEB User Accounts Page (for Users with 'Security Administrator' Privileges)**

Current Logged User: Admin	
▼ Account Data for User: Admin	
User Name	Admin <input type="button" value="Change User Name"/>
Access Level	Security Administrator
▼ Fill in the following 3 fields to change the password	
Current Password	<input type="text"/>
New Password	<input type="text"/>
Confirm New Password	<input type="text"/> <input type="button" value="Change Password"/>
▼ Account Data for User: User 2	
User Name	User 2 <input type="button" value="Change User Name"/>
Access Level	Administrator <input type="button" value="Change Access Level"/>
▼ Fill in the following 3 fields to change the password	
Current Password	<input type="text"/>
New Password	<input type="text"/>
Confirm New Password	<input type="text"/> <input type="button" value="Change Password"/>

2. To change the user name, perform the following:
  - a. In the 'User Name' field, enter the new user name (maximum of 19 case-sensitive characters).
  - b. Click **Change User Name**; the new user name is applied and the 'Enter Network Password' screen appears.
  - c. In the 'Enter Network Password' screen, enter the new user name.
3. To change the password, perform the following:
  - a. In the 'Current Password' field, enter the current password (maximum of 19 case-sensitive characters).
  - b. In the 'New Password' and 'Confirm New Password' fields, enter the new password.
  - c. Click **Change Password**; the new password is applied and the 'Enter Network Password' screen appears. In the 'Enter Network Password' screen, enter the new password.

## 3.6 Backing Up and Restoring Configuration

You can save a copy/backup of the device's current configuration settings (Voice) as an *ini* file to a folder on your PC, using the 'Configuration File' page. The saved *ini* file includes only parameters that were modified and parameters with other than default values. The 'Configuration File' page also allows you to load an *ini* file to the device. If the device has "lost" its configuration, you can restore the device's configuration by loading the previously saved *ini* file or by simply loading a newly created *ini* file.



**Note:** When loading an *ini* file using this Web page, parameters not included in the *ini* file are reset to default settings.

➤ **To save and restore the *ini* file:**

1. Open the 'Configuration File' page (**Management** tab > **Software Update** menu > **Configuration File**).

**Figure 3-8: Configuration File Page**

Configuration File

Save the **INI** file to the PC.

Send the **INI** file to the device.

The device will perform a reset after sending the **INI** file.

2. To save the *ini* file to a folder on your PC, perform the following:
  - a. Click the **Save INI File** button; the 'File Download' dialog box appears.
  - b. Click the **Save** button, navigate to the folder in which you want to save the *ini* file on your PC, and then click **Save**; the device copies the *ini* file to the selected folder.

➤ **To load (or restore) the ini file:**

1. Click the **Browse** button, navigate to the folder in which the *ini* file is located, select the file, and then click **Open**; the name and path of the file appear in the field beside the **Browse** button.
2. Click the **Load INI File** button, and then at the prompt, click **OK**; the device uploads the *ini* file and then resets (from the *cmp* version stored on the flash memory). Once complete, the 'Enter Network Password' dialog box appears, requesting you to enter your user name and password.

## 3.7 Restoring Factory Default Settings

You can use the device's hardware Reset button to restore all the device's configuration settings to factory defaults, including the device's IP address and Web interface's login user name and password. These default settings include factory defaults as well as user-defined defaults (refer to the device's *User's Manual*).



**Notes:**

- The device resets to the software version (*cmp* file) saved on its flash memory.
- For additional methods to restore default settings, refer to the *User's Manual*.

➤ **To restore the device to factory default settings:**

- With a paper clip or any other similar pointed object, press and hold down the Reset button (located on the CPU module) for at least 12 seconds (no more than 25 seconds); the device restores to factory default settings.

## 3.8 Upgrading the Device

You can upgrade the device with the following files, using the device's Web interface:

- Firmware (*cmp*) file using the Web interface's Software Update Wizard (refer to 'Software Upgrade Wizard' on page 51).
- Auxiliary and *ini* files using the 'Load Auxiliary Files' page (refer to 'Upgrading the ini and Auxiliary Files' on page 54).



**Note:** When upgrading the firmware (*cmp*), you can also use the Software Update Wizard to load the *ini* and auxiliary files.

### 3.8.1 Software Upgrade Wizard

The Software Upgrade Wizard allows you to easily upgrade the device's firmware (*cmp* file) as well as load an *ini* file and/or auxiliary files (e.g., Call Progress Tones). However, it is mandatory, when using the wizard to first load a *cmp* file to the device. You can then choose to also load an *ini* file and/or auxiliary files, but this cannot be pursued without first loading an *cmp* file. For the *ini* and each auxiliary file type, you can choose to load a new file, or not load a file, but use the existing file (i.e., maintain existing configuration) running on the device.

The Software Upgrade Wizard allows you to load the following files:

- **cmp:** (Mandatory) compressed firmware file
- **ini:** (Optional) Configuration file
- **Auxiliary files:** (Optional) CPT (Call Progress Tone), VP (Voice Prompts), PRT (Prerecorded Tones), CAS, and USERINF (User Info)



**Warnings:**

- To preserve all configuration settings, before upgrading the device to a new major software version (e.g., from version 5.8 to 6.0), save a copy of the device's configuration settings (i.e., *ini* file) to your PC and ensure that you have all the original auxiliary files (e.g., CPT file) currently used by the device. After you have upgraded the device, restore your configuration settings by uploading these files to the device. For backing up and restoring configuration, refer to 'Backing Up and Restoring Configuration' on page 49.
- The Software Upgrade Wizard requires the device to be reset at the end of the process, which may disrupt traffic. To avoid this, disable all traffic on the device before initiating the wizard, by performing a graceful lock (refer to 'Saving and Resetting the Device' on page 46).



**Notes:**

- Before you can load an *ini* or any auxiliary file, you must first load a *cmp* file.
- When you activate the wizard, the rest of the Web interface is unavailable. After the files are successfully loaded, access to the full Web interface is restored.
- You can schedule automatic loading of these files using HTTP, HTTPS, FTP, or NFS (refer to the *Product Reference Manual*).

➤ **To use the Software Upgrade Wizard:**

1. Stop all traffic on the device (refer to the note above).
2. Open the 'Software Upgrade Wizard' (**Management** tab > **Software Update** menu > **Software Upgrade Wizard**); the 'Software Upgrade Wizard' page appears.

**Figure 3-9: Start Software Upgrade Wizard Screen**

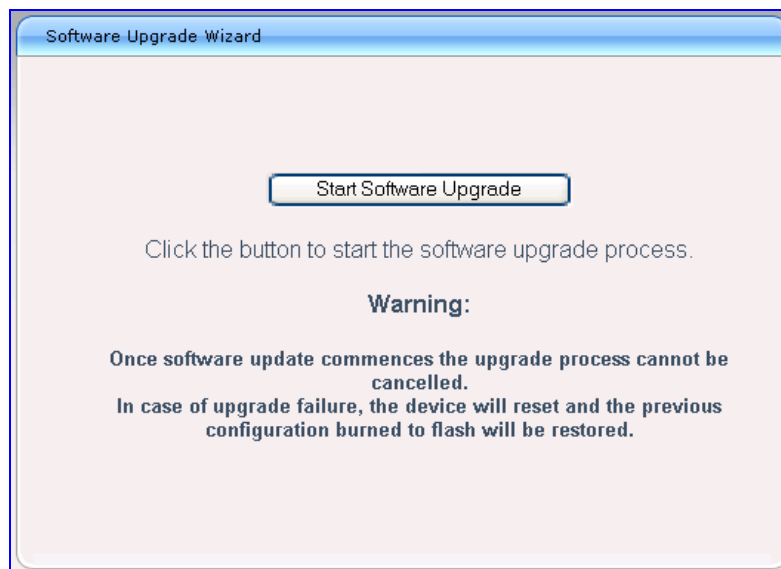



3. Click the **Start Software Upgrade** button; the 'Load a CMP file' Wizard page appears.

Figure 3-10: Load CMP File Wizard Page



**Note:** At this stage, you can quit the Software Update Wizard, by clicking **Cancel** , without requiring a device reset. However, once you start uploading a *cmp* file, the process must be completed with a device reset.

4. Click the **Browse** button, navigate to the *cmp* file, and then click **Send File**; the *cmp* file is loaded to the device and you're notified as to a successful loading.
5. Click one of the following buttons:

-  **Reset**; the device resets with the newly loaded *cmp*, utilizing the existing configuration and auxiliary files.
-  **Next**; the 'Load an *ini* File' wizard page opens.

Note that as you progress by clicking **Next**, the relevant file name corresponding to the applicable Wizard page is highlighted in the file list on the left.

6. In the 'Load an *ini* File' page, you can now choose to either:
  - Click **Browse**, navigate to the *ini* file, and then click **Send File**; the *ini* file is loaded to the device and you're notified as to a successful loading.
  - Use the *ini* file currently used by the device, by not selecting an *ini* file and by ensuring that the 'Use existing configuration' check box is marked (default).
  - Return the device's configuration settings to factory defaults, by not selecting an *ini* file and by clearing the 'Use existing configuration' check box.

7. You can now choose to either:
  - Click **Reset**; the device resets, utilizing the new *cmp* and *ini* file you loaded up to now as well as utilizing the other auxiliary files.
  - Click **Back**; the 'Load a *cmp* file' page is opened again.
  - Click **Next**; the next page opens for loading the next consecutive auxiliary file listed in the Wizard.
8. For loading the auxiliary files, follow the same procedure as for loading the *ini* file (Step 6).
9. In the 'FINISH' page, complete the upgrade process by clicking **Reset**; the device 'burns' the newly loaded files to flash memory and then resets the device. After the device resets, the 'End Process' screen appears displaying the burned configuration files (refer to the figure below).

**Figure 3-11: End Process Wizard Page**

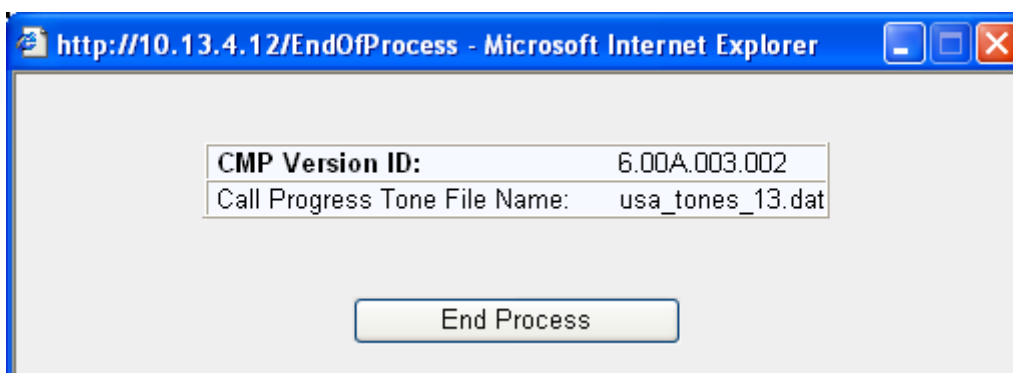

10. Click **End Process** to close the wizard, and then in the 'Enter Network Password' dialog box, enter your login user name and password (described in Accessing the Web Interface) and click **OK**; a message box appears informing you of the new CMP file.
11. Click **OK**; the Web interface now becomes active and reflecting the upgraded device.

### 3.8.2 Loading ini and Auxiliary Files

The auxiliary files (and *ini* file) are *dat* files that can be loaded to the device to provide enhanced device provisioning. These files are described in the table below. For detailed information on these files, refer to the device's *User's Manual*.

**Table 3-3: Auxiliary Files Descriptions**

File Type	Description
<i>ini</i>	Provisions the device's parameters. The Web interface enables practically full device provisioning, but customers may occasionally require new feature configuration parameters, in which case this file is loaded.  <b>Note:</b> Loading the <i>ini</i> file only provisions those parameters that are included in the <i>ini</i> file. Parameters not specified in the <i>ini</i> file are reset to factory default values.
CAS	Up to eight different CAS files containing specific CAS protocol definitions for digital modules. These files are provided to support various types of CAS signaling.
Voice Prompts	The voice announcement file contains a set of Voice Prompts (VP) that are played by the device during operation.
Dial Plan	Dial plan file.
Call Progress Tones	This is a region-specific, telephone exchange-dependent file that contains the Call Progress Tones (CPT) levels and frequencies that the device uses. The default CPT file is: U.S.A.
Prerecorded Tones	The <i>dat</i> PRT file enhances the device's capabilities of playing a wide range of telephone exchange tones that cannot be defined in the Call Progress Tones file.
User Info	The User Information file maps PBX extensions to IP numbers. This file can be used to represent PBX extensions as IP phones in the global 'IP world'.



**Notes:**

- The current settings of parameters that are not included in the *ini* file are retained (*incremental*).
- After loading the *ini* file, the device does not reset. Some files (e.g., Call Progress Tones) are not changeable on-the-fly and require a device reset.
- Saving an auxiliary file to flash memory may disrupt traffic on the device. To avoid this, disable all traffic on the device, by performing a graceful lock (refer to 'Saving and Resetting the Device' on page 46).
- You can also use BootP to load the auxiliary files to the device (refer to the *Product Reference Manual*).

➤ **To load an auxiliary file to the device:**

1. Open the 'Load Auxiliary Files' page (**Management** tab > **Software Update** menu > **Load Auxiliary Files**).

**Figure 3-12: Load Auxiliary Files Page**



The screenshot shows a web interface for loading auxiliary files. It contains six rows, each for a different file type. Each row has a text input field, a 'Browse...' button, and a 'Load File' button. The 'Call Progress Tones file' row has a lightning bolt icon to its left.

File Type	Input Field	Browse...	Load File
INI file (incremental)	<input type="text"/>	Browse...	Load File
CAS file	<input type="text"/>	Browse...	Load File
⚡ Call Progress Tones file	<input type="text"/>	Browse...	Load File
Prerecorded Tones file	<input type="text"/>	Browse...	Load File
Dial Plan file	<input type="text"/>	Browse...	Load File
User Info file	<input type="text"/>	Browse...	Load File

2. Click the **Browse** button corresponding to the file type that you want to load, navigate to the folder in which the file is located, and then click **Open**; the name and path of the file appear in the field next to the **Browse** button.
3. Click the **Load File** button corresponding to the field that contains the file you want to load.
4. Save to flash memory and reset (if required) the device (refer to 'Saving and Resetting the Device' on page 46).

## 4 Monitoring the Device

The operating status of the device can be monitored in the following ways:

- Monitoring the device's hardware front-panel LEDs (refer to 'Front-Panel LEDs' on page 57).
- Monitoring the device using the Web interface (refer to 'Web Interface' on page 58).

### 4.1 Front-Panel LEDs

The location of the device's front panel LEDs are shown in the figure below and described in the subsequent table.

Figure 4-1: Location of Front-Panel LEDs



Table 4-1: Analog I/O (FXS / FXO) Modules LEDs Description

I/O Port LED	Color	State	Description
RJ-11	Green	On	<ul style="list-style-type: none"> <li>■ FXS: phone is off-hooked.</li> <li>■ FXO: off-hooks the line toward the PBX.</li> </ul>
		Blinking	<ul style="list-style-type: none"> <li>■ FXS: rings the extension line.</li> <li>■ FXO: detects a ring signal from the PBX.</li> </ul>
	Red	On	Error (malfunction in line).

Table 4-2: E1/T1 PRI I/O TRUNKS Modules LED Description

LED	Color	State	Description
RJ-48c	Green	On	Trunk is synchronized (normal operation).
		Red	Loss due to any of the following signals: <ul style="list-style-type: none"> <li>■ LOS - Loss of Signal</li> <li>■ LOF - Loss of Frame</li> <li>■ AIS - Alarm Indication Signal (the Blue Alarm)</li> <li>■ RAI - Remote Alarm Indication (the Yellow Alarm)</li> </ul>
	-	Off	Failure / disruption in the AC power supply or the power is currently not being supplied to the device through the AC power supply entry.

**Table 4-3: BRI I/O Modules LED Description**

LED	Color	State	Description
RJ-45	Green	On	Physical layer (Layer 1) is synchronized (normal operation).
	Red	On	Physical layer (Layer 1) is not synchronized.
	-	Off	Trunk is not active.

**Table 4-4: Power Supply Module LED Description**

LED	Color	State	Description
POWER	Green	On	The LED of each AC power supply is lit green when the power supply is operating correctly.
	-	Off	Failure / disruption in the AC supply, or the power is currently not being supplied to the device through the AC power supply entry.

**Table 4-5: CPU Module LEDs Description**

LED	Item #	Color	State	Description
Ethernet Ports I & II	2 (Left LED)	Orange	Blinking	Activity.
		Green	On	Link OK.
	2 (Right LED)	Yellow	Blinking	Data is being received.
		-	Off	No link.
General Purpose	3	Green	N/A. (Future support.)	

## 4.2 Web Interface

The Web interface's 'Home' page provides a graphical display of the device's front panel, displaying color-coded icons depicting the status of the device's ports and channels, as well as other interfaces of the device. In addition, the 'Home' page allows you quick access to viewing active alarms.

### 4.2.1 Viewing Alarms

The 'Home' page allows you quick access to the 'Active Alarms' page (typically accessed from the **Status & Diagnostics** tab > **Status & Diagnostics** menu > **Active Alarms**). This page lists all the device's current alarms.

➤ **To view a list of current alarms:**

- In the 'Home' page, click the area labeled **Alarms**; the 'Active Alarms' page appears:

**Figure 4-2: Current Alarms in Active Alarms Page**

Severity	Source	Description	Date
Major	Board#1	Controller failure alarm Proxy Set 0: Proxy lost. looking for another proxy	8.1.2000 , 19:15:0.0

For each listed alarm, the following information is displayed:

- **Severity:** severity level of the alarm:
  - ◆ Critical (displayed in red)
  - ◆ Major (displayed in orange)
  - ◆ Minor (displayed in yellow)
  - ◆ No alarm (displayed in green)
- **Source:** element from which the alarm was generated
- **Description:** brief explanation of the alarm
- **Date:** date and time that the alarm was generated





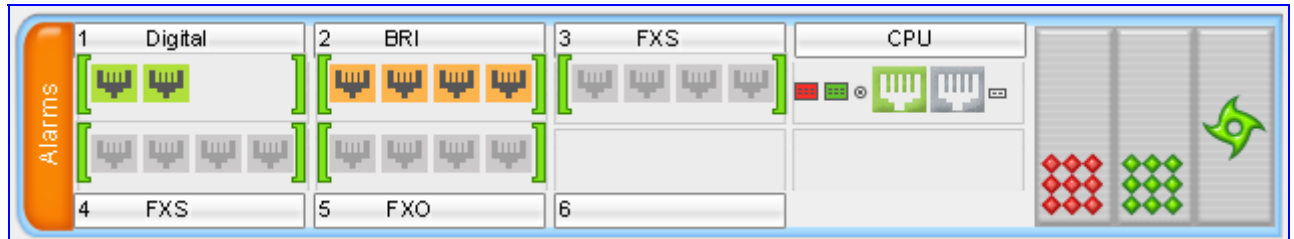

## 4.2.2 Viewing Channel Status

The 'Home' page displays channel port icons that indicate the voice channels' operating status. You can use these port icons to drill down to view detailed channel status. For a detailed description of the 'Home' page, refer to the device's User's Manual.

**Figure 4-3: Mediant 1000 Web Interface's Home Page**



**Table 4-6: Color-Coding of Trunk / Channel Status Icon**

Trunk / Channel Status Icon		Trunk (Digital Module)	Channel (Analog Module)
Icon State	Color	Description	Description
	Grey	Disable: Trunk not configured (not in use)	Inactive: Channel is currently on-hook
	Green	Active - OK: Trunk synchronized	Call Connected: Active RTP stream
	Yellow	RAI Alarm: Remote Alarm Indication (RAI), also known as the Yellow Alarm	-
	Red	LOS / LOF Alarm: Loss due to LOS (Loss of Signal) or LOF (Loss of Frame)	Not Connected: No analog line is connected to this port (FXO only)
	Blue	AIS Alarm: Alarm Indication Signal (AIS), also known as the Blue Alarm	Handset Offhook: Channel is off-hook, but there is no active RTP session
	Orange	D-Channel Alarm: D-channel alarm	-

You can drill-down to view a detailed status of each channel or trunk.

➤ **To view a detailed status of a channel or trunk:**

1. In the 'Home' page, click the port of whose status you want to view; a shortcut menu appears.
2. From the shortcut menu, choose **Port Settings**.

## 5 Open Solution Network (OSN) Server Platform

This section is intended for customers who wish to install the optional Open Solution Network (OSN) server platform functionality. The device's chassis houses a plug-in OSN Server module for hosting third-party, VoIP applications such as IP-PBX, Pre-Paid, and IP-PBX redundancy. The OSN server is a standalone entity, integrated within the device, using a separate Ethernet interface and IP configuration from that used by the device. The OSN platform includes a powerful processor and hard disks allowing you to host third-party applications such as IP-PBX, Pre-Paid, and IP-PBX redundancy.

The OSN server is available in one of the following models:

- OSN1 - OSN Server Ver. 1 module (refer to OSN 1/OSN2 Platform on page 61)
- OSN2 - OSN Server Ver. 2 module (refer to OSN 1/OSN2 Platform on page 61)

The main difference between OSN1 and OSN2 is that only OSN1 uses the Connection Module (CM), which provides the interface to the IP network. The network interface for OSN2 is through the iPMX module. The OSN1 is based on Intel Celeron (16 MHz). The OSN2 is based on Intel Pentium (1.4 GHz).

### 5.1 OSN1/OSN2 Hardware Installation

This section describes the hardware installation of the OSN server modules, which are housed in the device's chassis slots.



**Warning:** Before installing the OSN Server modules, ensure that the device is disconnected from the power supply. These modules are not hot-swappable and damage to these modules can occur if replaced under voltage.



**Note:** The Connection Module (CM), which provides connectivity to the IP network is only implemented for OSN1.

The device's OSN Server package includes the following modules:

- Connection module (CM) (installed in the front panel):

**Figure 5-1: Connection Module - CM (Only for Celeron-Based OSN Server)**





**Note:** The CM module is applicable only to OSN1.

- iPMX module (housed in the rear panel):

**Figure 5-2: iPMX Module (Only for OSN1)**



**Figure 5-3: iPMX Module (For OSN2)**



- Hard Drive module (HDMX) (housed in the rear panel):

**Figure 5-4: Hard Drive Module (HDMX)**



## 5.1.1 Required Working Tools

The following tools are required for installing the OSN Server module:

- Phillips screwdriver
- Flathead screwdriver
- Wire cutter

## 5.1.2 Installing the CM Module

The Connection Module (CM) is housed in the device's front panel.



**Note:** The CM module is applicable only to OSN1.

### ➤ To install the CM module:

1. On the device's front panel, use a Phillips screwdriver to remove the black metal cover plate from the slot located below the CPU module.
2. Insert the CM module into the empty slot, with the **plain** side of the Printed Circuit Board (PCB) facing up. Ensure the PCB slides into the slot rails, by aligning the CM with the rails in the slot.

**Figure 5-5: Inserting CM Module**

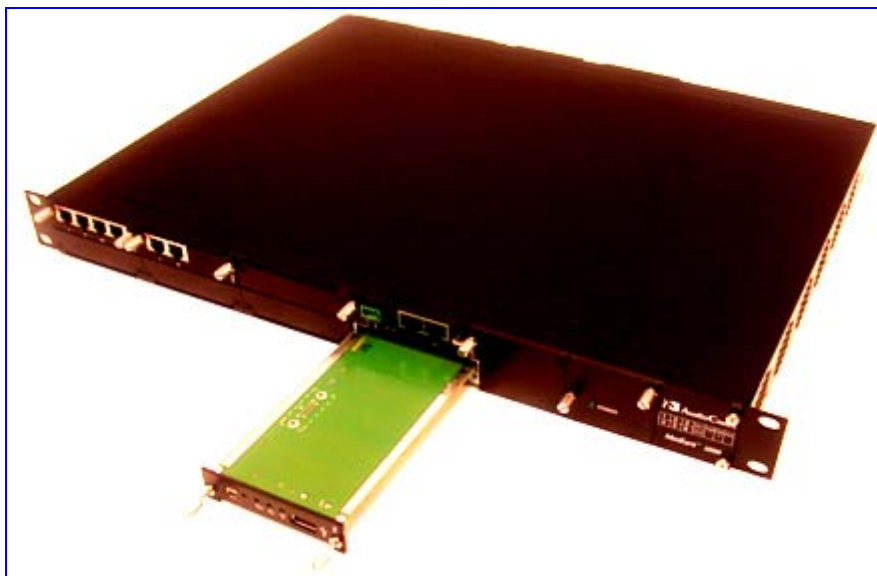

3. Gently push the CM module into the slot until it is fully inserted.
4. Using a flathead screwdriver, tighten the module's mounting pins.

### 5.1.3 Installing the iPMX Module

The iPMX module is installed on the rear panel of the device, as described in the following procedure:

➤ **To install the iPMX module:**

1. On the device's rear panel, remove the black metal cover plates in the first and second slots located on the right side of the power connection, as shown in the figure below.

**Figure 5-6: Cover Plates Removed**



2. Use the cutter tool to remove the small metal strip between the upper and lower slots, as shown in the figure below.

**Figure 5-7: Cutting Metal Strip**



3. Insert the iPMX module into the first slot, closest to the power connection, as shown in the figure below.

**Figure 5-8: Inserting iPMX Module**



4. Push the iPMX module into the slot and press on it firmly to ensure it has been fully inserted.
5. Using a flathead screwdriver, tighten the module's two captive mounting screws located on the bottom right and left corners.
6. Using a Philips screwdriver, tighten the module's two Philips screws located on the top right and left corners.

#### 5.1.4 Installing the HDMX Module

The Hard Drive module (HDMX) is installed on the rear panel of the device, as described in the following procedure:

➤ **To install the HDMX module:**

1. Place the device so that the rear panel is facing you.
2. Remove the black metal cover plates in the first and second slots located on the right side of the power connection.
3. Use the cutter tool to remove the small metal strip between the upper and lower slots.

4. Insert the HDMX module into the second slot, as shown in the figure below.

**Figure 5-9: Inserting HDMX Module**



5. Push the HDMX module into the slot and press on it firmly to ensure it has been fully inserted.
6. Using a flathead screwdriver, tighten the module's mounting pins.

### 5.1.5 Replacing the iPMX Module's Lithium Battery

The iPMX module is equipped with a 3-volt CR-1225 Lithium battery (AudioCodes product number: ACL P/N RBAT00001). Typically, battery life is estimated at two years. However, for various reasons, the battery may last for a shorter duration.



**Warnings:**

- When replacing the battery, all BIOS settings revert to factory defaults.
- When removing and inserting the battery, be careful not to touch other components on the iPMX printed circuit board (PCB) with the extracting tool. This may cause irreversible damage to the iPMX module.
- Dispose of used batteries according to the manufacturer's instructions. Failure to do so could result in environmental damage.
- The Lithium battery must only be replaced with an identical or equivalent battery, as recommended by the manufacturer.



**Electrical Component Sensitivity**

Electronic components on printed circuit boards are extremely sensitive to static electricity. Normal amounts of static electricity generated by clothing can damage electronic equipment. To reduce the risk of damage due to electrostatic discharge (ESD) when installing or servicing electronic equipment, it is recommended that anti-static earthing straps and mats be used.

The following procedure describes how to replace the Lithium battery in the iPMX module.

➤ **To replace the Lithium battery in the iPMX:**

1. Remove the iPMX module from the slot in which it's housed in the device rear panel, by performing the following:
  - a. Using a flathead screwdriver, loosen the module's two lower mounting captive screws.
  - b. Using a Philips screwdriver, loosen the two upper screws.
  - c. Holding the two mounting captive screws, gently pull the module out of the slot.
2. Flip the module over so that it lies face down with the PCB visible.
3. Locate the Lithium battery in its battery holder on the circuit board.
4. Using a tweezer-like tool (or small flathead screwdriver), carefully leverage the battery out of the battery holder. Be careful not to touch other components on the board with your tool.

**Figure 5-10: Removing Lithium Battery from iPMX Module**



5. For installing the new battery, simply push the battery into the battery holder using your fingers. Ensure that you install the battery in the correct orientation such that the positive side is facing up (i.e., the side containing the battery description is visible).
6. Re-insert the iPMX module into the slot of the device's chassis as described in the previous section.

## 5.2 Installing Linux™ on the OSN Server

This section describes the installation of the Linux operating system on the OSN server. The OSN server supports the following Linux™ OS distributions:

- Linux™ RedHat (and Fedora)
- Linux™ Debian
- Linux™ SUSE
- Linux™ CentOS

### 5.2.1 Requirements

Before installing Linux on the device's OSN Server, ensure the following hardware and software requirements are fulfilled:

- **Hardware requirements:**
  - Ethernet cable cord
  - External USB CD ROM or DVD ROM (not supplied)
  - USB cable (not supplied) to connect the external USB CD ROM to the device
  - RS-232 cable (supplied)
  - Linux™ Distributions Installation CDs
- **Software requirements:**
  - RS-232 console / terminal software (e.g., HyperTerminal™)

## 5.2.2 Cabling

The following procedure describes the cabling procedure before installing Linux™ on the device's OSN Server.

### 5.2.2.1 Cabling OSN1

The procedure below describes the OSN1 cabling for Linux installation. The cabling is performed on the CM module.

➤ **To cable OSN1:**

1. On the device's CM module, perform the following:
  - a. Connect the RS-232 port to a PC running Windows™, using the RS-232 cable.
  - b. Connect the USB port to an external CD-ROM drive, using the USB cable.

**Figure 5-11: Cabling OSN1 (CM Module)**

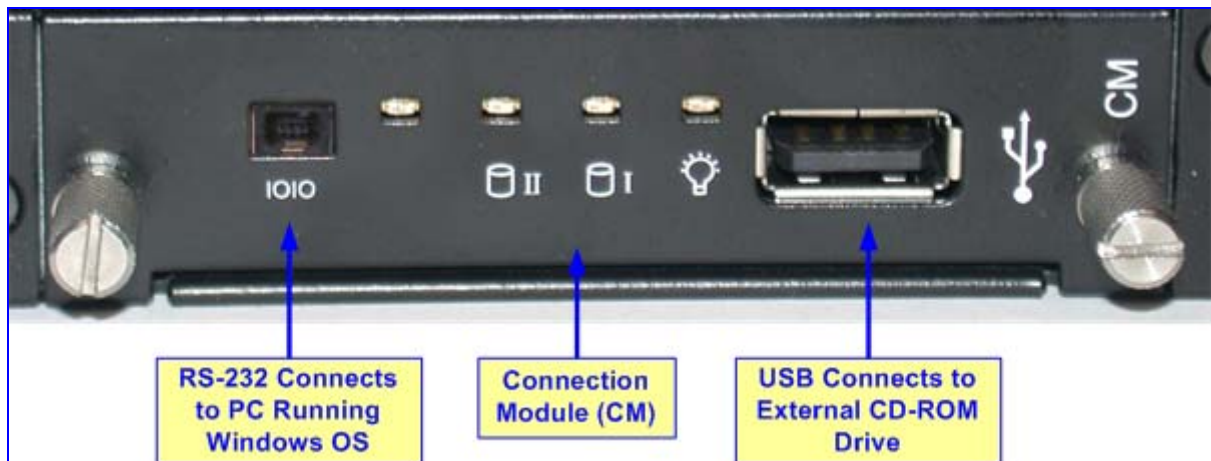

2. On the device's iPMX module, connect the RJ-45 Ethernet port, using the Ethernet cable.
3. Connect the external CD-ROM to the power supply.
4. Connect the device to the power supply.

### 5.2.2.2 Cabling OSN2

The procedure below describes the OSN2 cabling for Linux installation. The cabling is performed on the iPMX module.



**Note:** If you want to use the VGA port, you can order the VGA cable separately from AudioCodes.

➤ **To cable OSN2:**

1. On the device's iPMX module, perform the following:
  - a. Connect to the PC using one of the following methods:
    - ◆ Connect the RS-232 port to a PC, using the RS-232 cable.
    - ◆ Connect the VGA port to the monitor
  - b. Connect the USB port to an external CD-ROM drive, using the USB cable.
  - c. Connect the RJ-45 Ethernet port, using the Ethernet cable.
2. Connect the external CD-ROM to the power supply.
3. Connect the device to the power supply.

**Figure 5-12: Cabling OSN2 (iPMX Module in Rear Panel)**

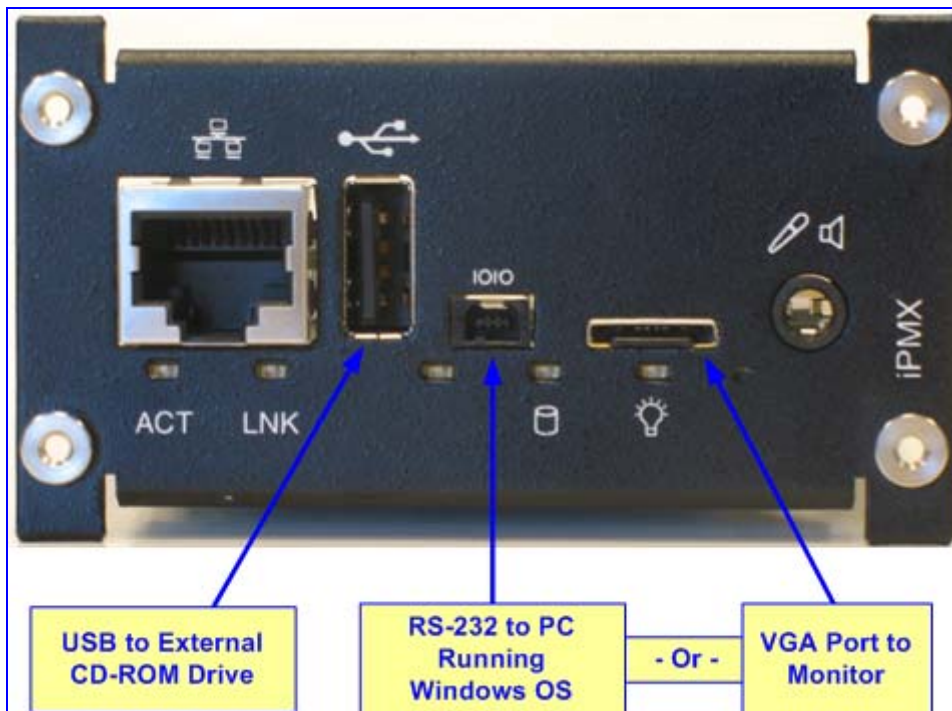

### 5.2.3 Installing Linux

Once you have cable the device as described in the previous section, you can install the Linux OS.

➤ **To install Linux on the OSN server:**

1. Start a terminal application (e.g. HyperTerminal) on your PC, and create a new connection with the following settings:
  - Connect Port: COM1
  - Baudrate: 115200 (bits per second)
  - Data Bits: 8
  - Parity: None
  - Stop Bits: 1
  - Flow Control: None
2. Power up the device.
3. Enable console installation from the system BIOS, by performing the following:
  - a. When the system starts, press the CTRL+C key; after several seconds, the following BIOS setup window is displayed:

**Figure 5-13: System BIOS Setup Window**

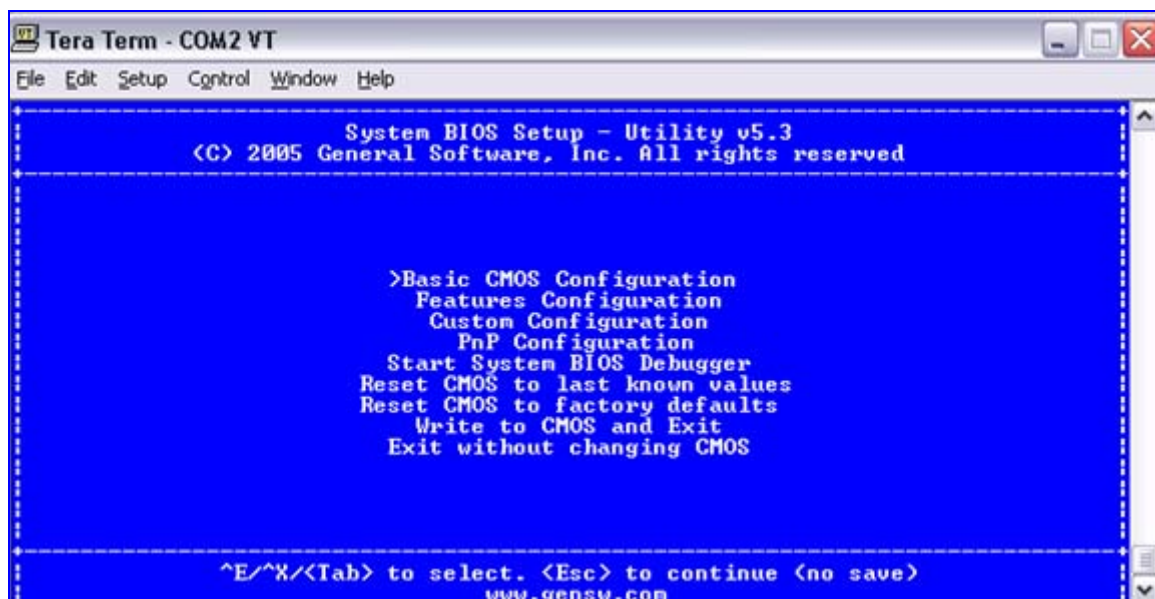

- b. Select the **Features Configuration** option.

- c. Change the System Management BIOS parameter to “Enabled”.

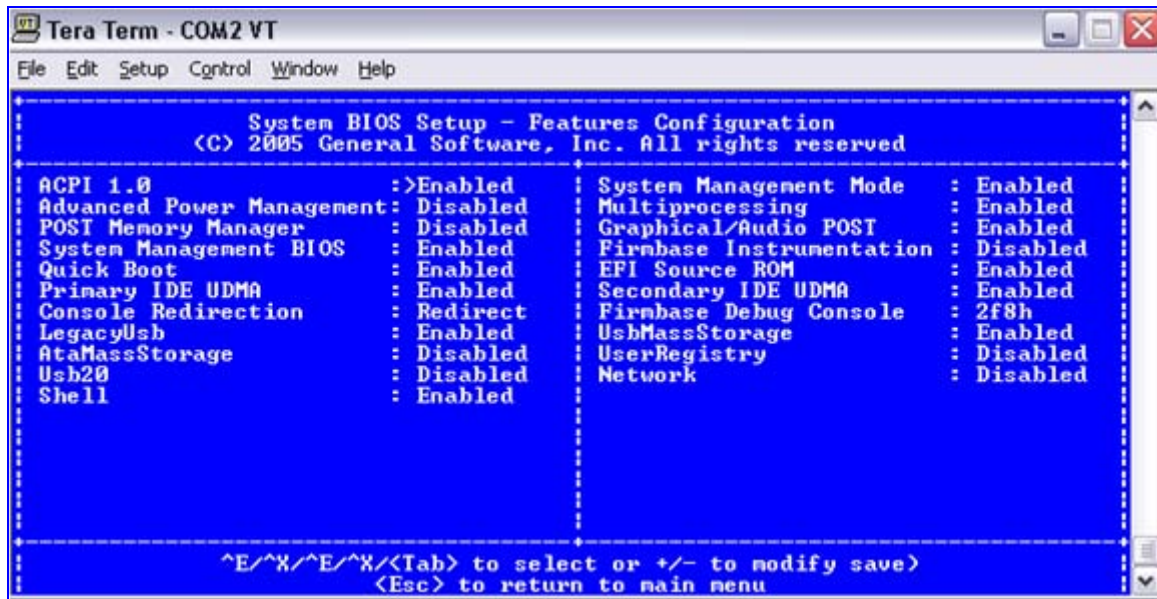
**Figure 5-14: Enabling System Management BIOS**

- d. Press the Esc key to return to the main BIOS window:

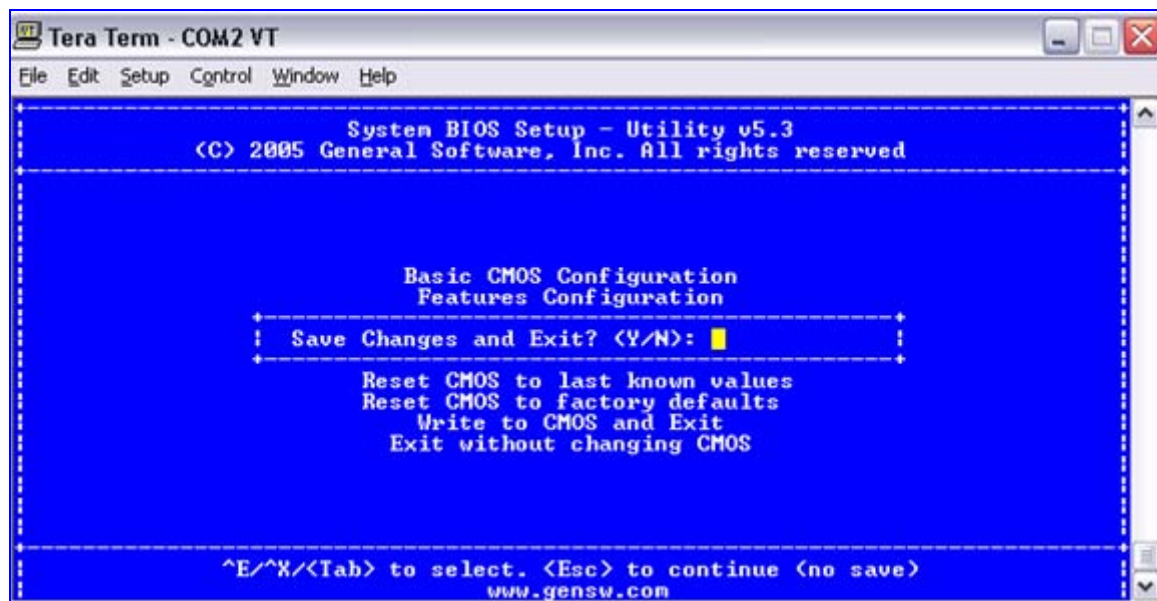
**Figure 5-15: Saving BIOS Settings**

- e. Choose the **Write to CMOS and Exit** option, and then press the Y key to save changes and exit.
4. Insert the Linux installation CD into the USB CD-ROM drive; the terminal application prompt appears.
5. At the prompt, type the following:  

```
linux text console=ttyS0,115200#
```



**Note:** Only one character is displayed each time you press a key.

6. Press the Enter key; the Linux installation begins.
7. Continue installation according to the Linux installation instructions.

## 5.3 Connecting Remotely to OSN Server using Windows

Typically, for customers requiring Microsoft Windows® operating system (OS), the OSN Server is provided with Windows pre-installed. You can connect to the OSN Server using Microsoft's Remote Desktop Connection program.



### Notes:

- To connect remotely to the OSN server running Windows, ensure that Remote Desktop is enabled.
- The remote PC must be in the same subnet as the OSN server (default IP address 10.10.12).

### 5.3.1 Cabling

Before you can connect remotely to the OSN Server, you need to cable a PC (running Remote Desktop Connection) to the OSN Server's IP interface. The OSN2 server connects to the IP network through the LAN port of the iPMX module.

#### ➤ To cable OSN2 for remote desktop connection:

- Connect the Ethernet LAN port of the device's iPMX module, to the LAN network, by performing one of the following:
  - **Remote PC connection:** using a straight-through cable, connect the iPMX LAN port to a switch that is connected to the IP network.
  - **Local PC connection:** using a crossover cable, connect the iPMX LAN port directly to the PC's LAN port.

Figure 5-16: Cabling iPMX for Remote Connection from PC with Windows XP

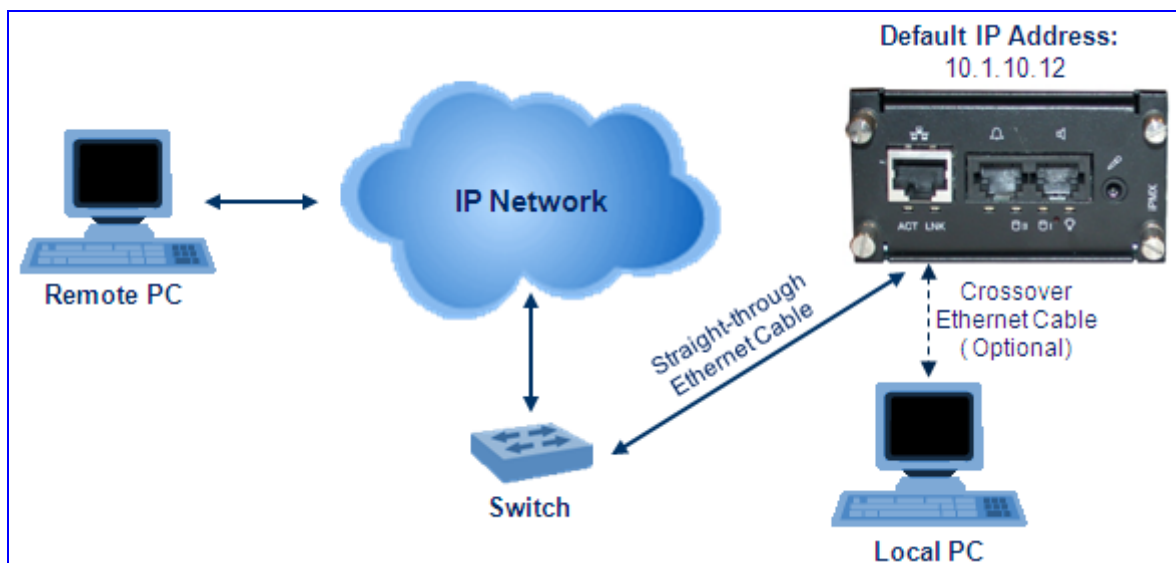

## 5.3.2 Connecting Using Remote Desktop Connection

Once you have cabled the PC to the OSN Server, perform the procedure below for connecting the PC remotely to the OSN Server (running Windows) using the Remote Desktop Connection program.

➤ **To remotely connect a PC to the OSN Server running Windows:**

1. Change the PC's IP address so that it is in the same subnet as the default OSN Server's IP address (i.e., 10.1.10.12). The figure below displays an example of a changing a PC's IP address:

**Figure 5-17: Changing the PC's IP Address**

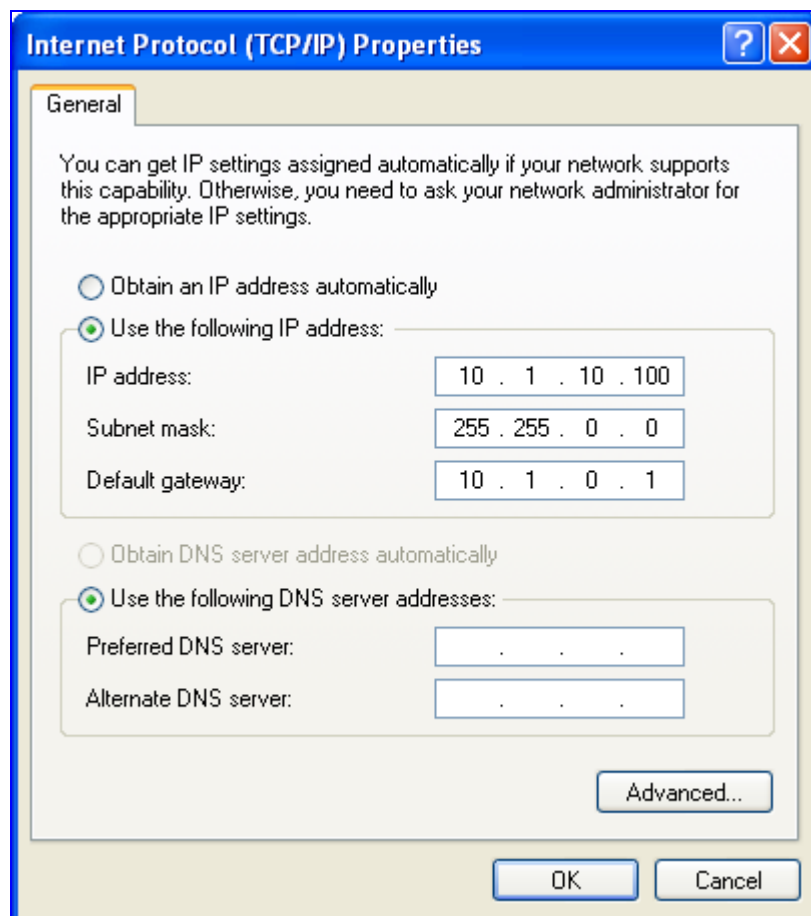

2. Start Microsoft's Remote Desktop Connection program - from the **Start** menu, point to **Programs**, to **Accessories**, to **Communications**, and then click **Remote Desktop Connection**.

**Figure 5-18: Entering IP Address in Remote Desktop Connection**

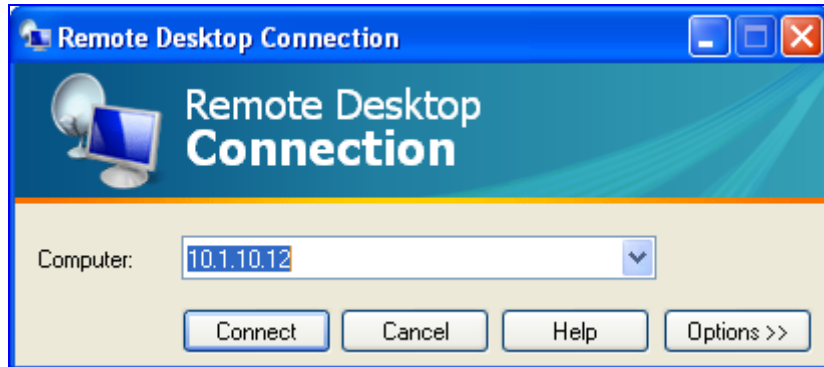

3. In the 'Computer' field, enter the OSN Server's default IP address (i.e., 10.1.10.12).
4. Click **Connect**.

**Figure 5-19: Entering User Name and Password in Remote Desktop Connection**



5. Enter the OSN Server's default user name (i.e., "administrator") and password (i.e., "1234").
6. Click **OK**; Remote Desktop Connection connects you to the desktop of the device's OSN server.

**SIP****Mediant 1000**

# Installation Manual

Version 6.0