



Octal Analog Series
A8A / A8B



User Manual



Digium, Inc.
445 Jan Davis Drive
Huntsville, AL 35806
United States
Main Number: 1.256.428.6000
Tech Support: 1.256.428.6161
U.S. Toll Free: 1.877.344.4861
Sales: 1.256.428.6262
www.digium.com
www.asterisk.org
www.asterisknow.org

© Digium, Inc. 2013
All rights reserved.

No part of this publication may be copied, distributed, transmitted, transcribed, stored in a retrieval system, or translated into any human or computer language without the prior written permission of Digium, Inc.

Digium, Inc. has made every effort to ensure that the instructions contained in this document are adequate and error free. The manufacturer will, if necessary, explain issues which may not be covered by this documentation. The manufacturer's liability for any errors in the documents is limited to the correction of errors and the aforementioned advisory services.

This document has been prepared for use by professional and properly trained personnel, and the customer assumes full responsibility when using it.

Adobe and Acrobat are registered trademarks, and Acrobat Reader is a trademark of Adobe Systems Incorporated.

Asterisk, Digium, Switchvox, and AsteriskNOW are registered trademarks and Asterisk Business Edition, AsteriskGUI, and Asterisk Appliance are trademarks of Digium, Inc.

Any other trademarks mentioned in the document are the property of their respective owners.

Compliance Information

Compliance information for this product is available at <http://www.digium.com/compliance>.

Introduction to Octal Analog Series Documentation

This manual contains product information for the Octal Analog Series card. Be sure to refer to any supplementary documents or release notes that were shipped with your equipment. The manual is organized in the following manner:

Chapter/ Appendix	Title	Description
1	Overview	Identifies the card and type of modules you received with your Octal Analog Series card. This chapter covers applications and uses of the Octal Analog Series card in the real world.
2	Card Installation	Provides instructions for installing the card in your PC, acquiring correct drivers, and checking device compatibility.
3	Configuration	Provides examples for configuring dial plan options.
4	FXS and FXO Explained	Describes the FXO (Foreign Exchange Office) and FXS (Foreign Exchange Station) modules and their significance.
5	Troubleshooting	Explains resolutions to common problems and frequently asked questions pertaining to card installation and usage.
A	Pin Assignments	Lists the connectors and pin assignments.
B	Specifications	Details card specifications.
C	Glossary and Acronyms	A list of terms and acronyms used throughout this manual.

Symbol Definitions



Caution statements indicate a condition where damage to the unit or its configuration could occur if operational procedures are not followed. To reduce the risk of damage or injury, follow all steps or procedures as instructed.



The ESD symbol indicates electrostatic sensitive devices. Observe precautions for handling devices. Wear a properly grounded electrostatic discharge (ESD) wrist strap while handling the device.



The Electrical Hazard Symbol indicates a possibility of electrical shock when operating this unit in certain situations. To reduce the risk of damage or injury, follow all steps or procedures as instructed.

Important Safety Instructions

User Cautions



Warning

This card must be used with the PC lid screwed down. Telecommunications network voltages exist inside the PC! The PC must be shut down and telecommunications line connection shall be removed before opening the PC.



Electrical Shock.

To reduce the risk of injury, damage to the unit or your equipment, do not attempt to touch the modules while they are powered. The case should be securely closed before power is applied to the unit.



Alarm Dialing Equipment.

If your home has specially wired alarm equipment connected to the telephone line, ensure the installation of the Octal Analog Series does not disable your alarm equipment. If you have questions, consult your telephone company or a qualified installer.



Servicing.

Do not attempt to service this card unless specifically instructed to do so. Do not attempt to remove the card from your equipment while power is present. Refer servicing to qualified service personnel.



Water and Moisture.

Do not spill liquids on this unit. Do not operate this equipment in a wet environment.



Heat.

Do not operate or store this product near heat sources such as radiators, air ducts, areas subject to direct, intense sunlight, or other products that produce heat.



Caution.

To reduce the risk of fire, use only No. 26 AWG or larger telecommunication wiring for network connections.

User Cautions



Caution.

This card is not intended for home use. It must be used in restricted access locations and installed in UL Listed I.T.E. only.



Static Electricity.

To reduce the risk of damaging the unit or your equipment, do not attempt to open the enclosure or gain access to areas where you are not instructed to do so. Refer servicing to qualified service personnel.

Save these instructions for future reference.

Service Personnel Cautions



Warning.

This card must be used with the PC lid screwed down. Telecommunications network voltages exist inside the PC! The PC must be shut down and telecommunications line connection shall be removed before opening the PC.



Electrical Shock.

To reduce the risk of injury, damage to the unit or your equipment, do not attempt to touch the modules while they are powered. The case should be securely closed before power is applied to the unit.



Servicing.

Disconnect telecommunications network cable before opening the cover or removing the card from the motherboard.



Labeling.

*For safety reasons, only connect equipment with a Telecommunications Compliance label. This includes customer equipment previously labelled **Permitted** or **Certified**.*



Caution.

Only connect regulatory equipment (approved for use in your specific country) to the telecommunications network voltage circuit ports.

Service Personnel Cautions



Caution.

This card is not intended for home use. It must be used in restricted access locations and installed in UL Listed I.T.E. only.

TABLE OF CONTENTS

Chapter 1

Overview	13
Echo-Cancellation	14
What is Asterisk®?	15
Asterisk as a Switch (PBX)	15
Asterisk as a Gateway	15
Asterisk in the Call Center	16
Asterisk in the Network	16
Asterisk Everywhere	16

Chapter 2

Card Installation	17
Unpacking the Card	18
Shipment Inspection	19
Module Identification	19
Port Identification	19
FXS and FXO Connection	23
Slot Compatibility	23
Hardware Installation	26
Software Installation	30
Installing Asterisk	34

Chapter 3

Configuration	36
----------------------------	-----------

Driver Configuration	37
Configuring Card Features	41
Voicemail	43
Dial Plan	44
Testing Your Configuration	45
Chapter 4	
FXS and FXO Explained	47
Identification	47
FXS Module	47
FXO Module	47
Using Your Octal Analog Series Card	48
Chapter 5	
Troubleshooting	49
Appendix A	
Pin Assignments	54
Appendix B	
Specifications	55
Appendix C	
Glossary and Acronyms	58

Figure 1:	Sample Card Application	13
Figure 2:	A8A Card with Four Single Modules	21
Figure 3:	A8B Card with Two Quad Modules	22
Figure 4:	Motherboard Slots	24
Figure 5:	Insert the Card	26
Figure 6:	Connect Power for FXS Modules	27
Figure 7:	Sample Application	46

Table 1:	Card Identifiers	32
Table A-1:	RJ11 Telco Port Connector	54
Table B-2:	Maximum Power Consumption	57

Chapter 1

Overview

The Octal Analog Series cards are versatile devices used for connecting your phone network to the PSTN (Public Switched Telephone Network) world. This is accomplished through phone lines connected to the FXO (Foreign Exchange Office) ports and phones connected via the FXS (Foreign Exchange Station) ports. The cards allow Asterisk to connect to your phone network, creating an office type telephony environment.

There are a variety of applications where the Octal Analog Series cards (A8A or A8B) can prove useful. An example is provided in the following figure.

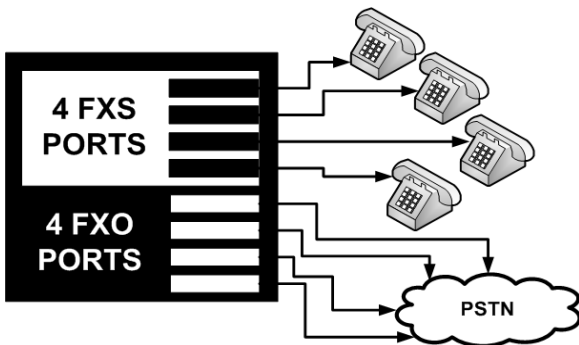

Figure 1: Sample Card Application

Note: An FXS module should be connected only to a device that is located inside of the same building to minimize lightning exposure.

Echo-Cancellation

Users connecting their Octal Analog Series cards to the PSTN or other devices are likely to be placing calls that will result, at some point, in an unbalanced 4-wire/2-wire hybrid. The result of this hybrid is the reflection of a near-end echo to the calling party. Elimination of this echo is the responsibility of echo cancellation.

The Octal Analog Series cards, unless otherwise equipped, utilize Asterisk to perform software-based echo cancellation. Asterisk maintains a number of open source echo cancelers. These open source echo cancelers provide a moderate level of echo cancellation, but are not capable of dealing with higher levels of, or more advanced, echoes.

Digium recommends that those users concerned about echo cancellation purchase the VPM032 hardware echo cancellation module. The VPM032 may be combined with both the A8A and A8B.

The VPM032 is designed to handle up to 128ms of echo cancellation across all channels and provides a G.168 echo cancellation solution.

What is Asterisk®?

Asterisk is the world's leading open source telephony engine and tool kit. Offering flexibility unheard of in the world of proprietary communications, Asterisk empowers developers and integrators to create advanced communication solutions...for free. Asterisk is released as open source under the GNU General Public License (GPL), and it is available for download free of charge. Asterisk is the most popular open source software available, with the Asterisk Community being the top influencer in VoIP.

Asterisk as a Switch (PBX)

Asterisk can be configured as the core of an IP or hybrid PBX, switching calls, managing routes, enabling features, and connecting callers with the outside world over IP, analog (POTS), and digital (T1/E1) connections.

Asterisk runs on a wide variety of operating systems including Linux, Mac OS X, OpenBSD, FreeBSD, and Sun Solaris. It provides all of the features you would expect from a PBX including many advanced features that are often associated with high end (and high cost) proprietary PBXs. Asterisk's architecture is designed for maximum flexibility and supports Voice over IP in many protocols, and can interoperate with almost all standards-based telephony equipment using relatively inexpensive hardware.

Asterisk as a Gateway

It can also be built out as the heart of a media gateway, bridging the legacy PSTN to the expanding world of IP telephony. Asterisk's modular architecture allows it to convert between a wide range of communications protocols and media codecs.

Asterisk as a Feature/Media Server

Need an IVR? Asterisk's got you covered. How about a conference bridge? Yep. It's in there. What about an automated attendant? Asterisk does that too. How about a replacement for your aging legacy voicemail system? Can do. Unified messaging? No problem. Need a telephony interface for your web site? Ok.

Asterisk in the Call Center

Asterisk has been adopted by call centers around the world based on its flexibility. Call center and contact center developers have built complete ACD systems based on Asterisk. Asterisk has also added new life to existing call center solutions by adding remote IP agent capabilities, advanced skills-based routing, predictive and bulk dialing, and more.

Asterisk in the Network

Internet Telephony Service Providers (ITSPs), competitive local exchange carriers (CLECS) and even first-tier incumbents have discovered the power of open source communications with Asterisk. Feature servers, hosted services clusters, voicemail systems, pre-paid calling solutions, all based on Asterisk have helped reduce costs and enabled flexibility.

Asterisk Everywhere

Asterisk has become the basis for thousands of communications solutions. If you need to communicate, Asterisk is your answer. For more information on Asterisk, visit <http://www.asterisk.org> or <http://www.digium.com>.

Chapter 2

Card Installation

This chapter provides the following information:

- **Unpacking the Card** on page 18
- **Shipment Inspection** on page 19
- **Module Identification** on page 19
- **Port Identification** on page 19
- **FXS and FXO Connection** on page 23
- **FXS and FXO Connection** on page 23
- **Slot Compatibility** on page 23
- **Hardware Installation** on page 26
- **Software Installation** on page 30
- **Installing Asterisk** on page 34

Unpacking the Card

When you unpack your card, carefully inspect it for any damage that may have occurred in shipment. If damage is suspected, file a claim with the carrier and contact the reseller from which the card was purchased, or contact Digium Technical Support at 1.256.428.6161. Keep the original shipping container to use for future shipment or proof of damage during shipment.



This card is intended for installation in a Restricted Access Location (RAL) only.

Shipment Inspection

The following items are included in shipment of an Octal Analog Series card:

- Octal Analog Series card (A8A or A8B)
- FXO and/or FXS module(s) (depending on configuration)
- VPM032 module (depending on configuration)

Module Identification

The Octal Analog Series card may ship with FXO and/or FXS modules in place. These are identified by their color. Take a moment to identify which modules were shipped with your card.

- FXO (Foreign Exchange Office) modules are Red
- FXS (Foreign Exchange Station) modules are Green

See Figure 2 on page 21 for an example of the A8A card shown with two of each single module.

See Figure 3 on page 22 for an example of the A8B card shown with one of each quad module.

The Octal Analog Series cards may also be combined with Digium's hardware-based echo canceler, model VPM032. See Figure 3 on page 22 for an example of the A8B card shown with one of each quad analog module and the echo cancellation module.

Port Identification

Each card consists of eight RJ11 ports located on the bracket. Each port correlates to a single module port (containing either FXO or FXS modules). The ports are numbered in sequence from one to eight. The top

port is Port 1 and the bottom port is Port 8. See Figure 2 on page 21 for appropriate identification of these ports. The port identification is the same for all cards in this series.

It is important to identify the type and location of your Octal Analog Series modules. You will need this information during the Asterisk configuration.

The ports available for use on the Octal Analog Series cards are not continuous. The ports available for use depend upon the type of module used, and the placement of the module on the card. The cards can accept 2 quad modules, for a total of 8 ports. If single modules are used, only 2 single modules can occupy the same space as a quad module. The single module ports are identified on the card and their corresponding RJ11 ports are identified below. Please refer to Figure 2 for an example using single modules, and Figure 3 for an example using quad modules.

If a single module is used, the RJ11 port available for use will be the port corresponding to the location of the module on the card. The following ports correspond to the single module ports as shown in Figure 2.

- RJ11 Port 1 is used by Single Module Port 1
- RJ11 Port 2 is used by Single Module Port 2
- RJ11 Port 5 is used by Single Module Port 5
- RJ11 Port 6 is used by Single Module Port 6

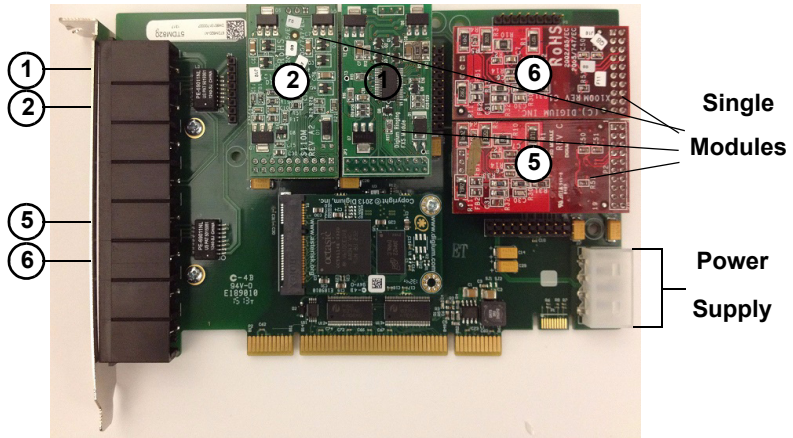

Figure 2: A8A Card with Four Single Modules

If a quad module is placed covering single module ports 1 and 2, then that module will use ports 1-4. Likewise, if a quad module is placed covering single module ports 5 and 6, the module will use ports 5 through 8. Figure 3 shows a A8B with two quad modules.

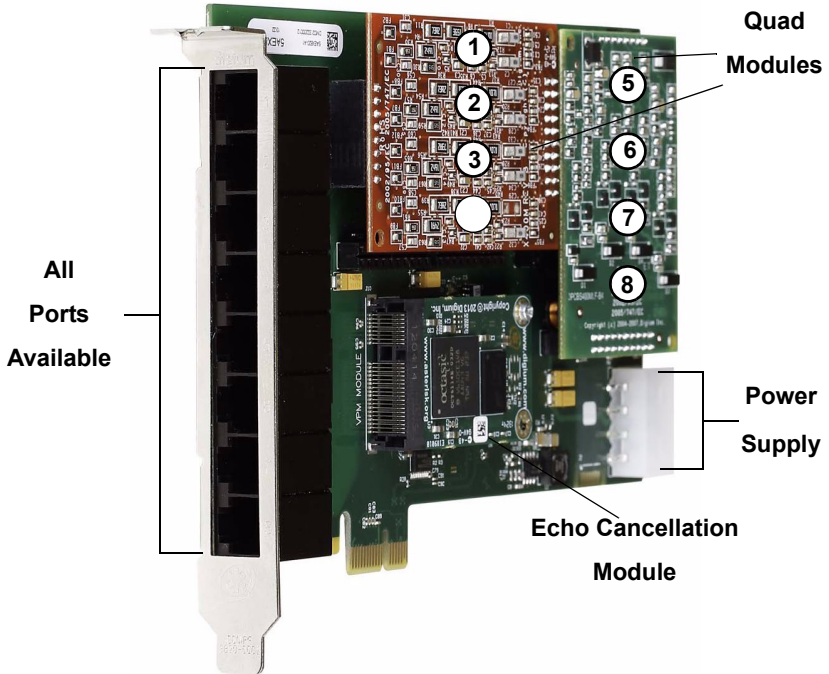

Figure 3: A8B Card with Two Quad Modules

FXS and FXO Connection

The Octal Analog Series cards provide eight RJ11 connectors for access to the FXS and/or FXO modules installed in the available slots. The diagram in Table A-1 on page 54 provides the pinout for this connector.



Caution.

Only qualified service personnel should continue with hardware installation and configuration of the Octal Analog Series card. Users should not attempt to perform these functions themselves. The installer must ensure that the equipment is permanently connected equipment, pluggable type B or connected to a socket-outlet that has been checked to ensure that it is reliably earthed in accordance with the National Electrical Code.

Slot Compatibility

Check your motherboard to verify that a compatible slot is available for a Octal Analog Series card. To determine which slots you have on your motherboard, identify them by comparing them to those shown in Figure 4.

Slot Number:

- 0: AGP Pro Slot
- 1: 64-bit 5.0 volt PCI Slot
- 2: 64-bit 3.3 volt PCI Slot
- 3: 32-bit 5.0 volt PCI Slot
- 4: PCI Express 1-lane (x1) Slot
- 5: PCI Express 4-lane (x4) Slot
- 6: PCI Express 8-lane (x8) Slot
- 7: PCI Express 16-lane (x16) Slot

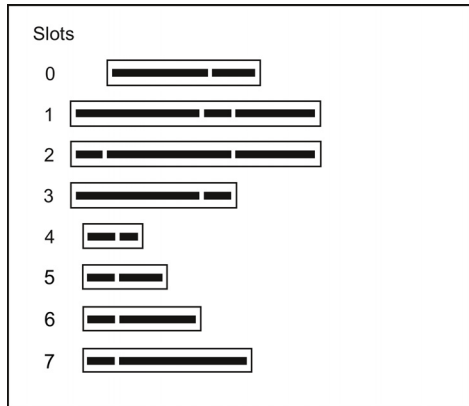

Figure 4: Motherboard Slots

The A4A card is a 32-bit 33MHz card keyed for universal 3.3 volt or 5.0 volt operation and works in any PCI 2.2 (or greater) compliant slot. This means that in the motherboard shown in Figure 4, the A4A card will fit into Slots 1, 2, or 3 (PCI slots), but **cannot** fit into Slot 0 (AGP slot) or Slots 4 through 7 (PCI Express slots).

The A4B card is keyed for a PCI Express 1-lane (x1) slot and will work in any PCIe revision 1.0 compliant slot, including lane lengths x4, x8, and x16. This means that in the motherboard shown in Figure 4, the A4B card will fit into Slots 4, 5, 6, or 7 (PCI Express), but **cannot** fit into any of the other slots.

Hardware Installation

1. Now that you are acquainted with your card, power down your computer and unplug it from its power source.
2. Attach a static strap to your wrist and open the case.
3. Remove the bracket place holder and insert the card into a PCI (A8A) or PCI Express (A8B) slot. See Figure 5.

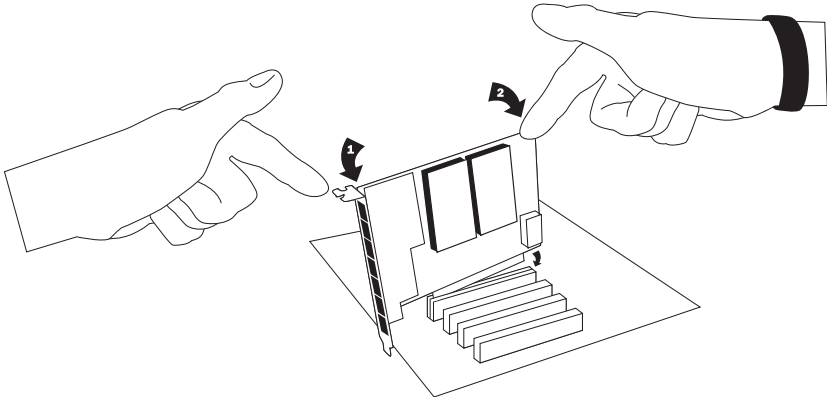

Figure 5: Insert the Card

4. If your card has any FXS modules, you will also need to connect the power cable from your computer's power supply to the back of the card. Insert a four-pin 12 volt connector (disk drive power supply cable, e.g. hard drive) into the power connector on the rear of the card. See Figure 6.

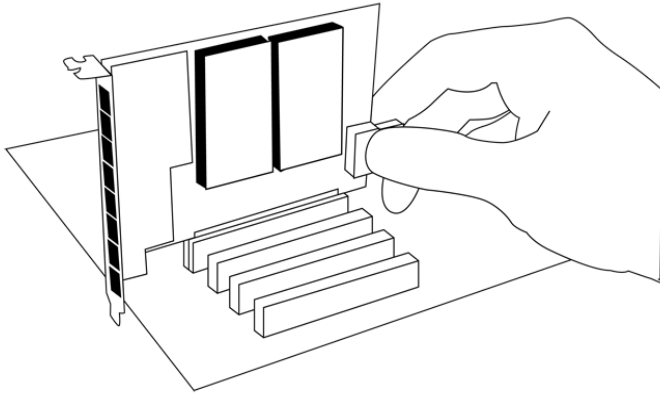

Figure 6: Connect Power for FXS Modules

Many modern PCs and servers do not have either spare or any 12V power connectors. If you have FXS modules on your card and your computer does not have power cables available, then power must be provided to the Octal Analog Series card by an alternate means. Digium provides a solution to this problem with the optional PWR2400B (available separately). This card is essentially a PCI bracket assembly that takes power from an external DC power supply and routes it to two 15" power cables inside the computer. You must have an available bracket slot to use the PWR2400B (either PCI, PCI Express or AGP).

A strap on the PWR2400B card allows the two power cables to take power from the same DC supply. The PWR2400B comes with one power supply capable of supporting up to 24 FXS ports each, driving heavy loads of up to 5REN. If more than 24 FXS ports with heavy loads are connected to the PWR2400B, then a second Digium power Supply should

be purchased. The shorting strap on the PWR2400B should be removed if a second power supply is used.

The PWR2400B does not connect to any bus inside the computer. It may be used wherever there is an available PCI-size bracket such as a PCI, PCI Express, or AGP slot.

Note: The PWR2400B is not intended to supply power to any other device, it is intended only to be used with UL Listed Digium analog cards.

5. Replace the cover to your computer.



Electrical Shock.

To reduce the risk of injury, damage to the unit or your equipment, do not attempt to apply power to the unit while the case is open. Personal injury or damage to the unit could occur if the modules are touched while powered is applied.

6. Plug all outside phone lines to the FXO ports (corresponding to the red modules) and connect all phones to the FXS ports (green modules) as needed using a patch panel or punch block. See Table A-1 on page 54 for the pin assignments.



Caution.

This unit must be connected to the Telecommunications Network in your country using an approved line cord, e.g.: for Australia use only line cords complying with AS/CA S008:2010.



Caution.

Only connect regulatory equipment (approved for use in your specific country) to the telecommunications network voltage circuit ports.

Software Installation

Digium hardware requires drivers and libraries that are not integrated with the Linux kernel. Digium hardware is only supported under Linux. Digium recommends CentOS, Debian, Red Hat, and Ubuntu distributions of Linux. However, many other distributions are supported by Digium Technical Support.

Digium's software, including drivers and application software, may be obtained from Digium's download server at:

<http://downloads.digium.com>

For an introduction to Asterisk, Digium's telephony software, including additional information on its configuration, setup, and features, please refer to:

<http://www.asterisk.org>

For the latest information on setting up and configuring DAHDI drivers for your Digium hardware product, please refer to the latest release of this manual which is available from the product-specific documentation section at:

<http://www.digium.com>

To install your Octal Analog Series card, you will need:

- Linux 2.6 kernel headers
- Development libraries and headers for ncurses
- Development libraries and headers for zlib and openssl
- Development libraries and headers for newt
- GCC and standard software build tools

It is recommended that you use the most recent version of the Asterisk, DAHDI, and libpri software for the best results. If you have previously

installed any of these, Digium recommends that you upgrade to the latest “-current” version of each.

Note: If you are using the 1.4.x series of Asterisk, you will need Asterisk 1.4.22 or newer.

1. After the machine has booted to Linux, log in and execute the following command to list the devices detected by the PCI bus:

```
# lspci -n
```

Confirm that the output from **lspci** lists a device with Digium’s PCI vendor ID which is “d161”. The screen output should be similar to the following:

```
0000:01:00.0 0200:d161:<card identifier>
```

Note: The output from **lspci** may or may not state “Unknown device”. If it does, this does not indicate a problem.

In the PCI device listing shown above, <card identifier> will be populated with one of the identifiers listed in the table below.

Table 1: Card Identifiers

Model	Identifier
A8A	080C
A8B	800D

A Digium Octal Analog Series (A8A / A8B) card identifier should be listed. If a matching card identifier is not listed, then your machine is not PCI 2.2 (or higher) or PCI Express compatible, and the card will not work with your motherboard.

2. Download the latest DAHDI drivers with tools. DAHDI is available for download from:

<http://downloads.digium.com/pub/telephony/dahdi-linux-complete>

```
# wget http://downloads.digium.com/pub/telephony/  
dahdi-linux-complete/dahdi-linux-complete-  
current.tar.gz
```

3. Expand the downloaded file, compile its contents, and install the drivers and tools. Substitute the version of DAHDI for the X.X.X in the command lines below.

```
# tar -zxvf dahdi-linux-complete-current.tar.gz
# cd dahdi-linux-complete-X.X.X+X.X.X
# make
# make install
# make config
```

Note: Executing ‘make config’ will install an init script and symlinks which will allow you to start and stop DAHDI as a service.

Installing Asterisk

If you wish to use Asterisk with your new hardware, you can follow the instructions below.

1. Download the latest release version of Asterisk, either 1.4.22 (or later), 1.6.0.1 (or later), or 1.8.0 (or later). Substitute the version of Asterisk for the X.X in the command below. Asterisk is available for download from:

<http://downloads.digium.com/pub/telephony/asterisk>

```
# wget http://downloads.digium.com/pub/telephony/  
asterisk/asterisk-X.X-current.tar.gz
```

2. Expand the downloaded file, compile its contents, and install the application. Substitute the version of Asterisk for the X.X and X.X.X in the command lines below.

```
# tar -zxvf asterisk-X.X-current.tar.gz  
# cd asterisk-X.X.X/  
# ./configure  
# make menuselect  
# make  
# make install
```

3. If this is the first Asterisk installation on this system, you should install the sample configuration files. To do this, run:

```
# make samples
```

Note: Running this command will overwrite, after making a backup copy, any older Asterisk configuration files that you have in the `/etc/asterisk` directory.

If your installation has failed, it may be because you are missing one or more of the build dependencies, the kernel headers, or the development tools. Please contact your reseller where the card was purchased, or call Digium Technical Support at 1.256.428.6161 for assistance.

Complete instructions for installing Asterisk are available at www.asterisk.org.

Chapter 3

Configuration

The Octal Analog Series cards have a variety of configuration options. This chapter provides sample configurations to demonstrate customizing the Asterisk software to meet your individual needs. Each section explains basic options as examples. Once you have familiarized yourself with the samples, you can edit the configuration files to meet your specific needs.

Driver Configuration

1. Begin by opening the **system.conf** file from the **/etc/dahdi** directory.
2. Specify the two letter country code for your loadzone and defaultzone. This will preload tone zone data and specify a default tone zone for your interfaces.

The following is a typical setup for a telco in the US:

```
loadzone = us  
defaultzone = us
```

3. Specify the channel definitions. The format is:

<device> = <channel list>

A list of valid devices are specified in the sample system.conf file.

If your card has any red FXO modules, add the following to system.conf:

fxsks =

fxsks uses kewlstart signalling, which is loopstart signalling with disconnect supervision. For example, an A8A card with 8 FXO ports would be configured as the following:

fxsks = 1-8

OR

fxsks = 1,2,3,4,5,6,7,8

You should have identified the type of Octal Analog Series card when you received it. If you are not sure, refer to **Module Identification** on page 19 for assistance.

Note: The Octal Analog Series cards do not support Ground Start signaling.

4. If your card has any green FXS modules, add the following:

fxoks =

fxoks uses kewlstart signalling, which is loopstart signalling with disconnect supervision. For example, an A8A card with 8 FXS ports would be configured as the following:

fxoks = 1-8

OR

fxoks = 1,2,3,4,5,6,7,8

5. An example configuration for an A8A card with 4 FXS and 4 FXO ports would be:

fxoks = 1-4

fxsks = 5-8

OR

fxoks = 1,2,3,4

fxsks = 5,6,7,8

6. DAHDI uses modular echo cancellers that are configured per channel. The echo cancellers are compiled and installed as part of the dahdi-linux package. You can specify the echo canceller to be used for each channel. The default behavior is for there to be no echo canceller on any channel. So, it is very important that you specify one in the

system.conf file if you do not have hardware echo cancellers and need echo cancellation. The format is:

```
echocanceller = <echocanceller name>,<channel(s)>
```

A list of valid echo cancellers are specified in the sample system.conf file.

The following is a typical setup using software-based echo cancellation:

```
echocanceller = mg2,1-8
```

7. Load DAHDI drivers into the kernel using the **modprobe** utility. The appropriate driver for the Octal Analog Series cards is **wcaxx**. Users should use the following modprobe command:

```
# modprobe wcaxx  
# dahdi_cfg -vv  
# dmesg
```

Configuring Card Features

You will need to modify the **chan_dahdi.conf** file which is located in the `/etc/asterisk` directory in order to configure the essential features of your card. This file is the configuration layer between DAHDI and Asterisk.

The following is a sample configuration for a A8A card with 4 FXS and 4 FXO ports. You can place this at the bottom of your **chan_dahdi.conf** file.

```
;General options
usecallerid = yes
hidecallerid = no
callwaiting = yes
threewaycalling = yes
transfer = yes
echocancel = yes
echocancelwhenbridged = yes
rxgain = 0.0
txgain = 0.0
;FXS Modules
group = 1
signalling = fxo_ks
context = Internal
channel = 1-4

;FXO Modules
group = 2
echocancel = yes
signalling = fxs_ks
```

```
context = Incoming  
channel = 5-8
```

Users of Digium's hardware echo cancellation module, the VPM032, should set the echocancel option to "yes." The module will automatically configure itself to run at full capacity, 1024 taps (128ms), on each channel.

Users without the VPM032 using open source echo cancelers included with DAHDI should configure echocancel to the values 128 (16ms) or 256 (32ms). Setting "yes" will default the option to 128 (16ms).

Users who have not purchased an Octal Analog Series card with the hardware echo cancellation module are encouraged to take advantage of Digium's High Performance Echo Canceler software. This commercially licensed software, which is made available at no charge to in-warranty Digium analog interface card customers, provide toll quality echo cancellation, performed on the host CPU, at up to 1024 taps (128ms) per channel. For further details about HPEC, please refer to the Digium website here:

<http://www.digium.com/en/products/software/hpec.php>

When HPEC is enabled, users may set the value of the echocancel parameter to any of the following values:

- 128 - 16ms
- 256 - 32ms
- 512 - 64ms
- 1024 - 128ms

Note: Higher values will result in dramatically increased CPU consumption. In order to optimize system performance, users are

encouraged to choose the minimum value required to cancel their echo.

Voicemail

Open **voicemail.conf** and find the following line at the bottom:

```
[default]
1234 => 4242,Mark Spencer,root@localhost
```

In this example, **1234** is the mailbox number, **4242** is the password, **Mark Spencer** is the person's name, and **root@localhost** is his email address.

You can add extensions by adding the following:

```
1000 => 1234,Moose Member,moose@digium.com
2000 => 1234,Chris Hogan,chogan@digium.com
```

Dial Plan

Open **extensions.conf**, which contains a large, complex sample dial plan. In this step, you will configure a basic dial plan to enable you to send and receive calls. Go to the bottom of the file and add the following lines:

```
[Internal]
```

```
exten => 1000,1,Dial(DAHDI/1,20,rt)
exten => 1000,2,Voicemail(1000,u)
exten => 1000,102,Voicemail(1000,b)
```

```
exten => 2000,1,Dial(DAHDI/2,20,rt)
exten => 2000,2,Voicemail(2000,u)
exten => 2000,102,Voicemail(2000,b)
```

```
exten => 8500,1,VoiceMailMain
exten => 8501,1,MusicOnHold
```

```
exten => _9.,1,Dial(DAHDI/g2/www${EXTEN:1})
exten => _9.,2,Congestion
```

```
[Incoming]
```

```
exten => s,1,Answer
exten => s,2,Dial(DAHDI/g1,20,rt)
exten => s,3,Voicemail(1000,u)
exten => s,103,Voicemail(1000,b)
```

In this example there are two internal extensions (1000 and 2000), a number to check voicemail (8500), a number to listen to music-on-hold, (8501), and a prefix to dial to get an outside line (9). It is configured to accept incoming calls over the FXO, rings phones 1 and 2, and route to voicemail box 1000.

Testing Your Configuration

1. Start Asterisk by typing:

```
asterisk
```

2. Connect to Asterisk and view the output by typing:

```
asterisk -vvvv
```

3. Dial tone should be present on phones connected to the FXS ports. Test your configuration by placing an outgoing call, placing a call from extension 1 to 2, or receiving an incoming call. Successful completion of these tasks indicates your configuration is working properly.

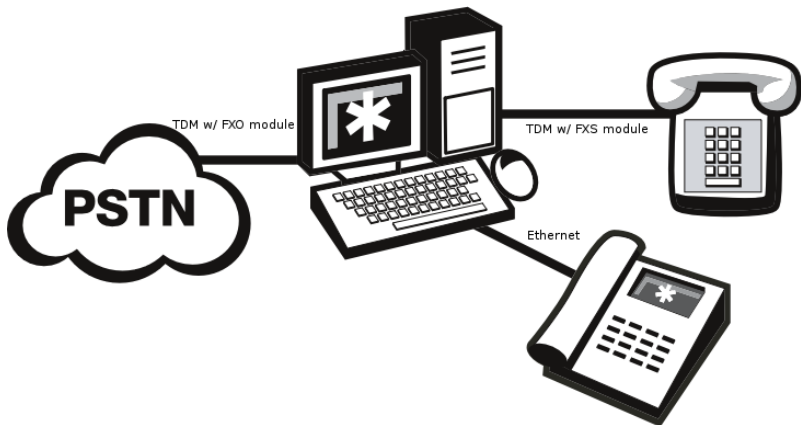

Figure 7: Sample Application

Note: More detailed information is provided at the Asterisk website (www.asterisk.org), as well as the Digium Knowledge Base (kb.digium.com). You may also obtain assistance by contacting Digium Technical Support at 1.256.428.6161 or visiting the website at www.digium.com.

Chapter 4

FXS and FXO Explained

Identification

There are multiple standard configurations in which an Octal Analog Series card may be purchased. Each configuration consists of one to four FXS and/or FXO modules. These modules are identified by their color.

- **FXS** - Foreign Exchange Station (Green Modules)
- **FXO** - Foreign Exchange Office (Red Modules)

This chapter provides an in-depth review of the two module types and their uses within your Asterisk server.

Note: Only qualified service personnel should install the card. Users should not attempt to perform this function themselves.

FXS Module

The FXS module allows an Octal Analog Series card to initiate and send ringing voltage to an FXO device such as an analog telephone.

FXO Module

The FXO module allows an Octal Analog Series card to terminate analog telephone lines (POTS). Because of the modular design, you can activate additional ports at any time with more FXS or FXO daughter cards. The FXO module passes all the call features any standard analog telephone line will support. The phone receiving the call is the last FXO device in the chain. When it receives voltage from an FXS device, the phone rings.

Using Your Octal Analog Series Card

Connect an outside line to an FXO port on your Asterisk server to receive voltage from the outside line.

Connect phones to FXS ports on your Asterisk server. The recommended maximum distance from an FXS module to its connected device is 1,500 ft. (457m). When the FXO module in your Asterisk Server receives the voltage, it will then generate voltage using the FXS module and send it to your analog phone.

Note: An analog phone line originating from an FXS module must remain inside the same building as the FXS module. In addition, an analog phone line originating from an FXS module must not be bundled with a line or lines that go outside the building where the FXS module is located.



Caution.

FXS modules are not equipped with lightning protection and should not be exposed to high voltage. Lightning or high voltage can cause damage to an FXS module. Damage caused by lightning or high voltage will void the product warranty.

Chapter 5

Troubleshooting

This chapter provides frequently asked questions and possible resolutions as identified by Digium Technical Support. Multiple resources are available to obtain more information about Asterisk and Digium products. Please visit both www.digium.com and www.asterisk.org for more information.

The FXO module never seems to hang-up the line. How do I set it to hang-up?

Set **busydetect = yes** and **busycount = 10** in the **chan_dahdi.conf** for your channels. This will cause the line to hang-up by listening for a consecutive number of busy tones. Upon editing **chan_dahdi.conf**, you will need to restart Asterisk.

I have echo problems on my FXO modules and I've tried the different echo cancellation algorithms in dahdi_config.h, tried tweaking the gains, and still nothing works. What can I do?

Run the **fxotune** utility with the **-i** option (**fxotune -i 4**). It should discover which DAHDI channels are FXO modules and tune them accordingly. Be warned however, it takes a significant amount of time for each module to tune. A conservative estimate would be somewhere around 2-3 minutes for each module. You only have to tune the channels once for each line. The **fxotune** utility will store the calibration settings in **/etc/fxotune.conf**. You will need to configure your system to run **fxotune** with the **-s** flag (**fxotune -s**) during the Linux boot sequence in order to initialize the previously discovered values which are stored in **fxotune.conf**. A recommendation is to put **'fxotune -s'** in your distribution's startup scripts at some point after the DAHDI module loads and before Asterisk executes.

Note: The digit after the **-i** option is the digit that will break dialtone on the line.

There is a slight echo. How can I adjust the sound quality?

There are several options available to correct this. Each involves editing the **chan_dahdi.conf** file. Be sure to restart Asterisk upon completion.

1. Adjust **echocancel = yes** to one of the following values: **32, 64, 128, or 256**.
2. You can also set **echotraining = yes**.
3. You can also adjust the **rxgain** and the **txgain**, although it is only recommended to shift between **-5** and **5**.

How can I enable more features?

To view all of the options available to add to your dial plan, type the following commands from within Asterisk:

```
*CLI> core show applications
```

```
*CLI> core show functions
```

Digium also offers services to help configure and add features you might need. Contact Digium Technical Support at 1.877.DIGIUM.1 (1.877.344.4861) for more information.

Common Fixes

1. Check to see if the X Window System (e.g. X.Org Server) is running by entering the following:

```
# ps aux | grep X
```

If the X Window System is running, stop the application since it may cause a conflict with Asterisk.

2. Check to see if your PATA IDE hard drives are running with DMA levels set. Advance user can perform an **hdparm** on your hard drive interface.



Use hdparm with caution as the man page states that hard drive corruption can occur when using incorrect settings. Please review the man page for hdparm and make sure you understand the risks before using this tool.

Check the current mode using this command:

```
hdparm -vi /dev/[IDE Device]
```

Use this command to set the drives into UDMA2 mode:

```
hdparm -d 1 -X udma2 -c 3 /dev/[IDE Device]
```

If you are still having problems, contact your reseller from which the card was purchased, or Digium Technical Support at 1.877.DIGIUM.1 (1.877.344.4861).

Where can I find answers to additional questions?

There are several places to inquire for more information about Asterisk Digium products:

1. Digium Technical Support (+1.256.428.6161), or Toll Free in the U.S. (1.877.344.4861), is available 7am-8pm Central Time (GMT -6), Monday - Friday.
2. Asterisk users mailing list (asterisk.org/lists.digium.com).
3. IRC channel **#asterisk** on (irc.freenode.net).

Subscription Services Program

Digium is dedicated to supporting your Asterisk system by offering full technical support through our Subscription Services Program. Through this program, you can be at ease knowing that your business will always have access to the Asterisk experts. Pricing on Subscription Services may be obtained from your nearest reseller or you may call Digium Sales for referral to your nearest reseller at +1.256.428.6000 or e-mail sales@digium.com.

Appendix A

Pin Assignments

All eight ports on the Octal Analog Series card's bracket are 6-pin RJ11 ports. The pin assignments are identified in Table A-1.

Table A-1: RJ11 Telco Port Connector

	Pin	Description
 Pin 1 Pin 6	1	Not used
	2	Not used
	3	Tip
	4	Ring
	5	Not used
	6	Not used

Appendix B

Specifications

This appendix provides specifications, required environmental conditions, and maximum power consumption for the Octal Analog Series cards.

Physical (All Cards).

Size: 6.18" × 4.21" × 0.591" (15.7cm x 10.7cm x 1.5cm)
PCB size, does not include the PCI bracket.

Check your model carefully to be sure it will accept this PCI card.

Weight: 4.5 oz (127.58 gm) with no modules loaded
Each quad module adds 1 oz (28.35 g)

Interfaces.

Local Loop Access: Industry standard 6-pin RJ-11.

Note: FXS modules are not equipped with lightning protection and should not be exposed to high voltage. Lightning or high voltage can cause damage to an FXS module. Damage caused by lightning or high voltage will void the product warranty.

The recommended maximum distance from an FXS module to its connected device is 1,500 ft. (457m).

(A8A) - PCI Bus: 3.3V or 5V bus slot, half-length full-height PCI card, 33MHz minimum bus speed, compliant with PCI 2.2 or greater.

Additional Power: four-pin 12V connector for FXS power supply (required only if FXS modules are installed)

(A8B) - PCI-E X1, compliant with PCI-E X1 1.0 or greater.

Environment.

Temperature: 0 to 50° C (32 to 122° F) operation

-20 to 65° C (-4 to 149° F) storage

Humidity: 10 to 90% non-condensing

Note: Operating temperature is limited to 0 to 40° C (32 to 104°F) when used with optional PWR2400B Power Bracket.

Hardware and Software Requirements.

500-Mhz Pentium III or better

64MB RAM

Available PCI or PCI-Express Slot (as described previously)

Power Consumption.

The following table lists the power consumption for both the A8A card (and its permutations) and the A8B card (and its permutations).

Note: 3.3 and 5 volt power is taken from the PCI slot. 12 volt power is taken only from the four-pin hard disk drive connector or optional PWR2400B.

Table B-2: Maximum Power Consumption

Power Source	Max Power
PCI A8A	5W
PCI-e A8B	7W
12V power connector	
No FXS ports	0W
4 FXS into 2 ren	6.5W
8 FXS into 5 ren	13W

Appendix C

Glossary and Acronyms

ANSI *American National Standards Institute*

An organization which proposes and establishes standards for international communications.

asynchronous

Not synchronized; not timed to an outside clock source. Transmission is controlled by start bits at the beginning and stop bits at the end of each character. Asynchronous communications are often found in internet access and remote office applications.

attenuation

The dissipation of a transmitted signal's power as it travels over a wire.

bandwidth

The capacity to carry traffic. Higher bandwidth indicates the ability to transfer more data in a given time period.

bit

The smallest element of information in a digital system. A bit can be either a zero or a one.

bps *bits per second*

A measurement of transmission speed across a data connection.

broadband

Broadband transmission shares the bandwidth of a particular medium (copper or fiber optic) to integrate multiple signals. The channels take up different frequencies on the cable, integrating voice, data, and video over one line.

channel

A generic term for an individual data stream. Service providers can use multiplexing techniques to transmit multiple channels over a common medium.

Cat5

Category of Performance for wiring and cabling. Cat 5 cabling support applications up to 100 MHz.

Cat5E

Category of Performance for wiring and cabling. Category 5 Enhanced wiring supports signal rates up to 100 MHz but adheres to stricter quality specifications.

CLEC *competitive local exchange carrier*

A term for telephone companies established after the Telecommunications Act of 1996 deregulated the LECs. CLECs compete with ILECs to offer local service. See also *LEC* and *ILEC*.

CO *central office*

The CO houses local switching equipment. All local access lines in a particular geographic area terminate at this facility (which is usually owned and operated by an ILEC).

CPE *customer premises equipment*

Terminal equipment which is connected to the telecommunications network and which resides within the home or office of the customer. This includes telephones, modems, terminals, routers, and television set-top boxes.

DAHDI *Digium Asterisk Hardware Device Interface*

A telephony project dedicated to implementing a reasonable and affordable computer telephony platform into the world marketplace. Also, the collective name for the Digium-provided drivers for Digium telephony interface products.

DS0 *Digital Signal, Level 0*

A voice grade channel of 64 Kbps. The worldwide standard speed for digitizing voice conversation using PCM (Pulse Code Modulation).

DS1 *Digital Signal, Level 1*

1.544 Mbps in North America (T1) and Japan (J1) - up to 24 voice channels (DS0s), 2.048 Mbps in Europe (E1) - up to 32 voice channels (DS0s). DS1/T1/E1 lines are part of the PSTN.

DS3 *Digital Signal, Level 3*

T3 in North America and Japan, E3 in Europe. Up to 672 voice channels (DS0s). DS3/T3/E3 lines are not part of the PSTN.

DTMF *Dual Tone Multi-Frequency*

Push-button or touch tone dialing.

E1

The European equivalent of North American T1, transmits data at 2.048 Mbps, up to 32 voice channels (DS0s).

E3

The European equivalent of North American T3, transmits data at 34.368 Mbps, up to 512 voice channels (DS0s). Equivalent to 16 E1 lines.

EMI *Electromagnetic Interference*

Unwanted electrical noise present on a power line

full duplex

Data transmission in two directions simultaneously.

FXO *Foreign Exchange Office*

Receives the ringing voltage from an FXS device. Outside lines are connected to the FXO port on your Octal Analog Series card.

FXS *Foreign Exchange Station*

Initiates and sends ringing voltage. Phones are connected to the FXS ports on the Octal Analog Series card.

G.711

A recommendation by the Telecommunication Standardization Sector (ITU-T) for an algorithm designed to transmit and receive mulaw PCM voice and A-law at a digital bit rate of 64 Kbps. This algorithm is used for digital telephone sets on digital PBX.

G.723.1

A recommendation by the Telecommunication Standardization Sector (ITU-T) for an algorithm designed to transmit and receive audio over telephone lines at 6.3 Kbps or 5.3 Kbps.

G.729a

A recommendation by the Telecommunication Standardization Sector (ITU-T) for an algorithm designed to transmit and receive audio over telephone lines at 8 Kbps.

H.323

A recommendation by the Telecommunication Standardization Sector (ITU-T) for multimedia communications over packet-based networks.

IAX *Inter-Asterisk eXchange*

The native VoIP protocol used by Asterisk. It is an IETF standard used to enable VoIP connections between Asterisk servers, and between servers and clients that also use the IAX protocol.

iLBC *internet Low Bitrate Codec*

A free speech codec used for voice over IP. It is designed for narrow band speech with a payload bitrate of 13.33 kbps (frame length = 30ms) and 15.2 kbps (frame length = 20 ms).

ILEC *incumbent local exchange carrier*

The LECs that were the original carriers in the market prior to the entry of competition and therefore have the dominant position in the market.

interface

A point of contact between two systems, networks, or devices.

ISO *International Standards Organization*

LED *light-emitting diode*

Linux

A robust, feature-packed open source operating system based on Unix that remains freely available on the internet. It boasts dependability and offers a wide range of compatibility with hardware and software. Asterisk is supported exclusively on Linux.

loopback

A state in which the transmit signal is reversed back as the receive signal, typically by a far end network element.

MGCP *Media Gateway Control Protocol*

multiplexing

Transmitting multiple signals over a single line or channel. FDM (frequency division multiplexing) and TDM (time division multiplexing) are the two most common methods. FDM separates signals by dividing the data onto different carrier frequencies, and TDM separates signals by interleaving bits one after the other.

MUX *multiplexer*

A device which transmits multiple signals over a single communications line or channel. See multiplexing.

PBX *private branch exchange*

A smaller version of a phone company's large central switching office. Example: Asterisk.

PCI *peripheral component interconnect*

A standard bus used in most computers to connect peripheral devices.

POP *point of presence*

The physical connection point between a network and a telephone network. A POP is usually a network node serving as the equivalent of a CO to a network service provider or an interexchange carrier.

POTS *plain old telephone service*

The public switched telephone network (PSTN) is the network of the world's public circuit-switched telephone networks. Originally a network

of fixed-line analog telephone systems, the PSTN is now almost entirely digital, and now includes mobile as well as fixed telephones.

PPP *point-to-point protocol*

Type of communications link that connects a single device to another single device, such as a remote terminal to a host computer.

PSTN *public switched telephone network*

A communications network which uses telephones to establish connections between two points. Also referred to as the dial network.

QoS *quality of service*

A measure of telephone service, as specified by the Public Service Commission.

RJ11

A six-pin jack typically used for connecting telephones, modems, and fax machines in residential and business settings to PBX or the local telephone CO.

SIP *Session Initiation Protocol*

An IETF standard for setting up sessions between one or more clients. It is currently the leading signaling protocol for Voice over IP, gradually replacing H.323.

T1

A dedicated digital carrier facility which transmits up to 24 voice channels (DS0s) and transmits data at 1.544 Mbps. Commonly used to carry traffic to and from private business networks and ISPs.

T3

A dedicated digital carrier facility which consists of 28 T1 lines and transmits data at 44.736 Mbps. Equivalent to 672 voice channels (DS0s).

TDM *time division multiplexer*

A device that supports simultaneous transmission of multiple data streams into a single high-speed data stream. TDM separates signals by interleaving bits one after the other.

telco

A generic name which refers to the telephone companies throughout the world, including RBOCs, LECs, and PTTs.

tip and ring

The standard termination on the two conductors of a telephone circuit; named after the physical appearance of the contact areas on the jack plug.

twisted pair

Two copper wires commonly used for telephony and data communications. The wires are wrapped loosely around each other to minimize radio frequency interference or interference from other pairs in the same bundle.

V *volts*

VoIP *Voice over IP*

Technology used for transmitting voice traffic over a data network using the Internet Protocol.